

Plan PB-26-1V _ind5 : Huisserie bois -

Pose tableau

Gamme porte de communication

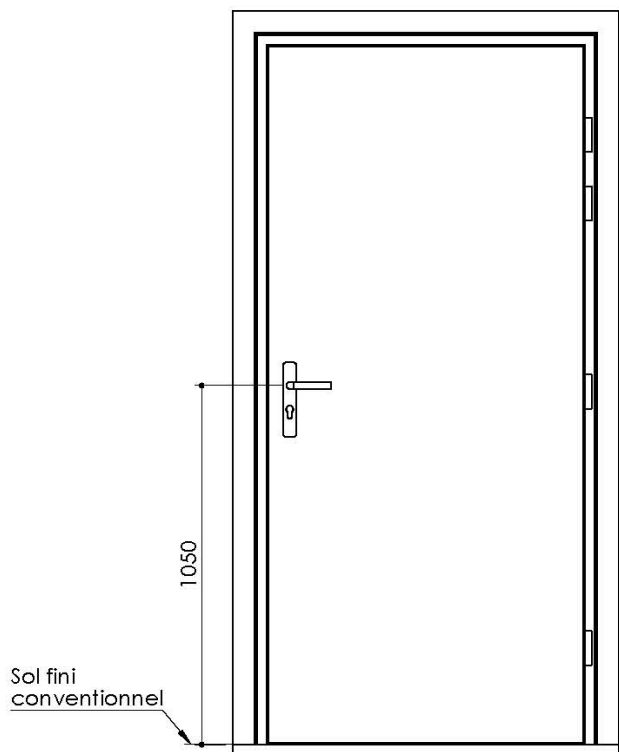

Huisserie non isophonique

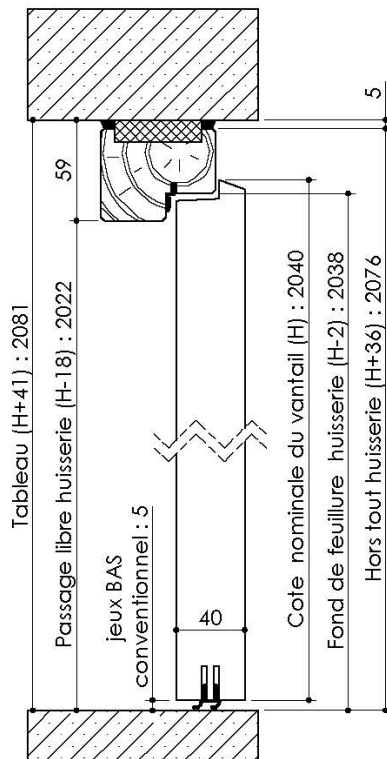

Huisserie isophonique

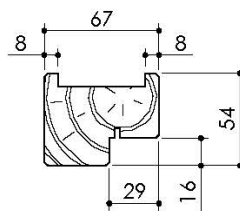
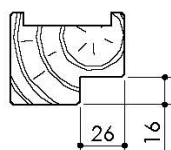

Variantes bas de porte

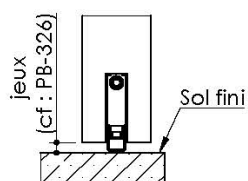

Plinthe automatique

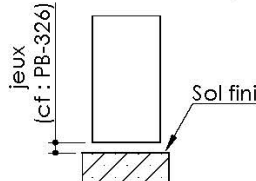

Sans joint balai

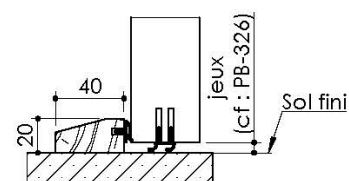

Seuil à la suisse + joint balai

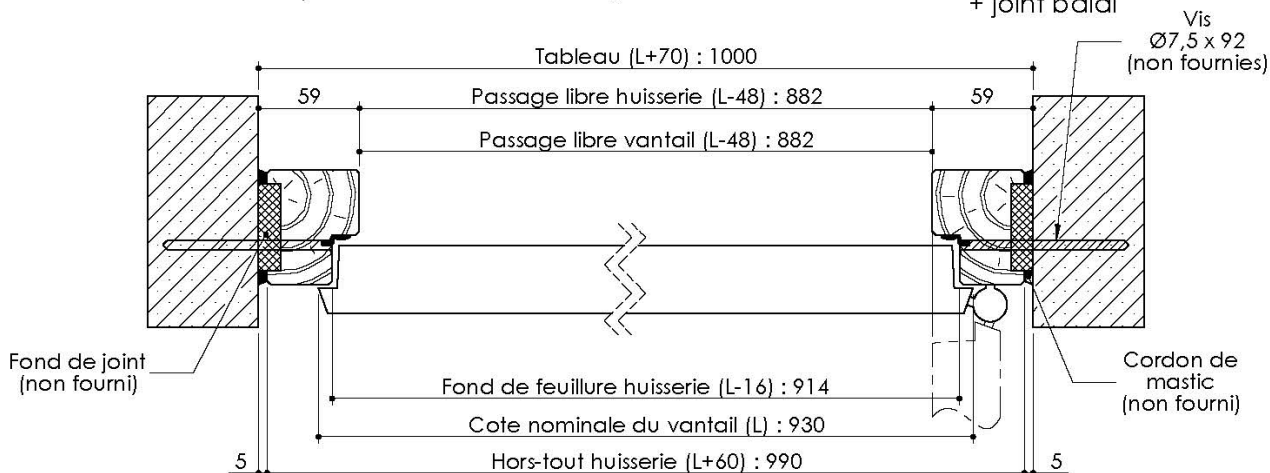

PB-26-1V 14/12/2021

Plan PB-26-ICE-2V _ ind6 : Huisserie bois -

Pose tableau

Gamme porte de communication

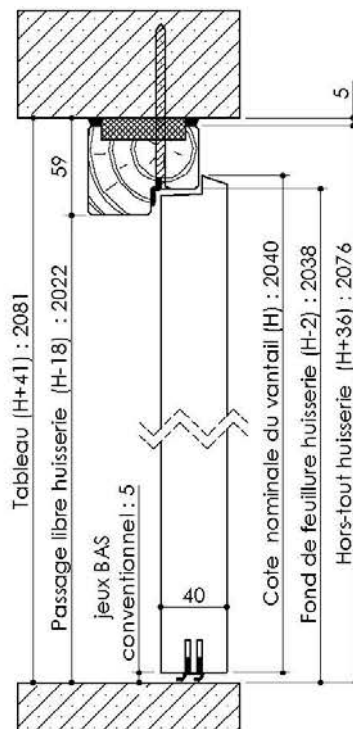
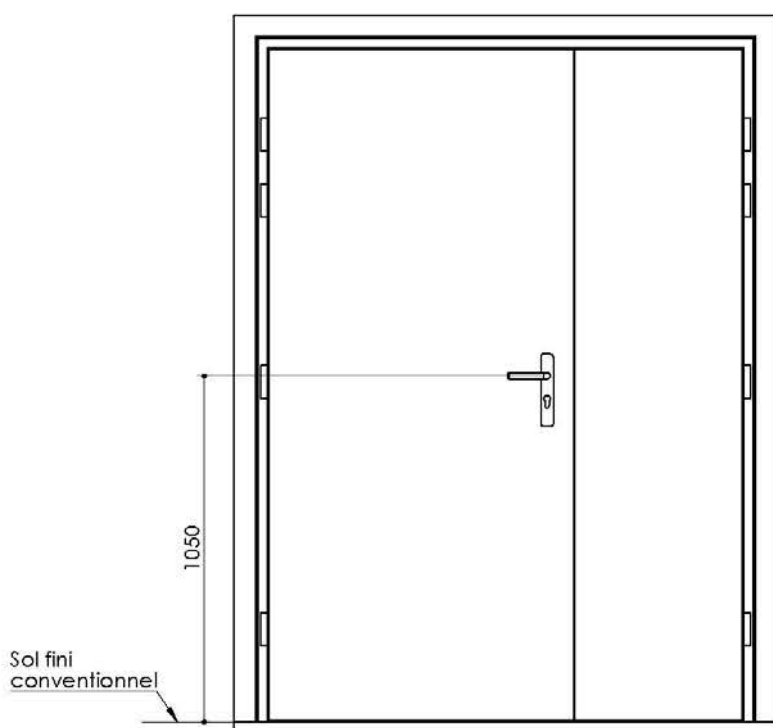

Huisserie non isophonique

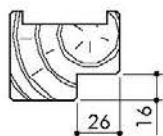

Huisserie isophonique

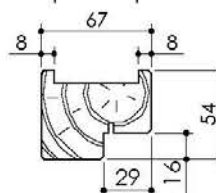

Variantes bas de porte

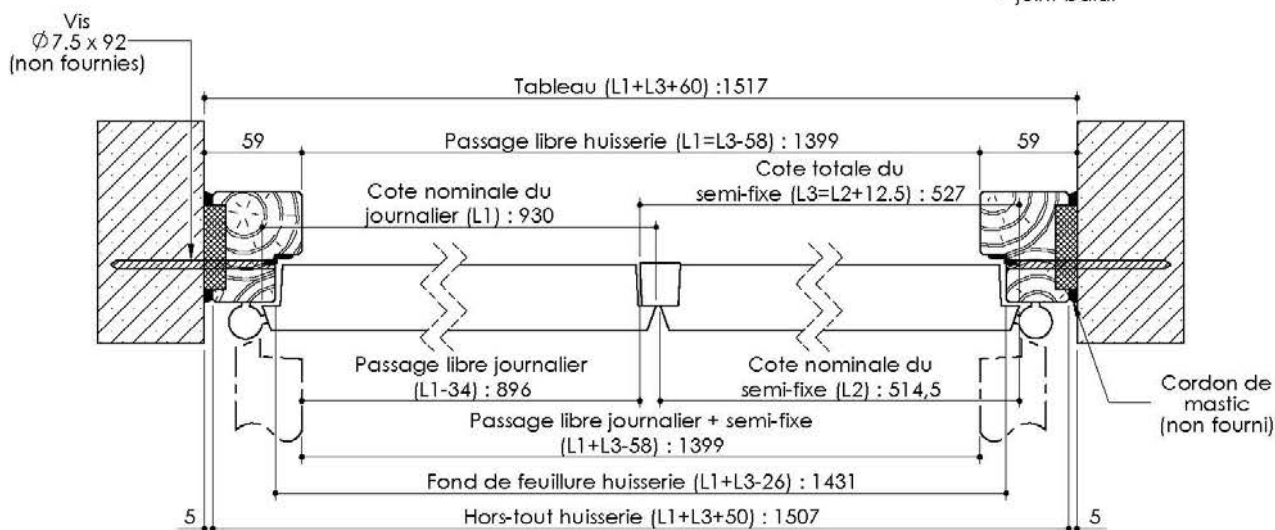
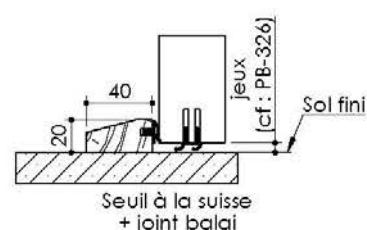
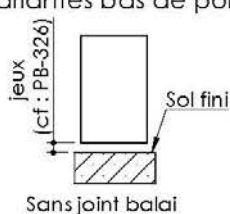
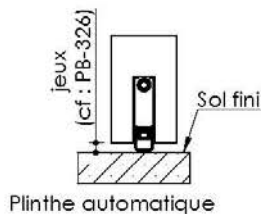

KEYOR

PB-26-ICE-2V 14/12/2021

Plan non contractuel, Keyor se réserve le droit de modifier ce plan pour des raisons industrielles