

Plan PB-31-B-1V _ Ind2 : Huisserie bois - Pose fin de chantier - Easy'M-Blanc

Gamme Porte de Communication



Tableau (H+35) : 2075±5
 Passage libre huisserie (H-11) : 2029
 Fond de feuillure huisserie (H) : 2040
 Cote nominale du vantail (H) : 2040
 Hors tout huisserie (H+47) : 2087



Kit	Epaisseur cloison	Epaisseur cloison avec extenseur E
A	de 50 à 75	de 150 à 175
B	de 75 à 100	de 175 à 200

Détail bas de porte

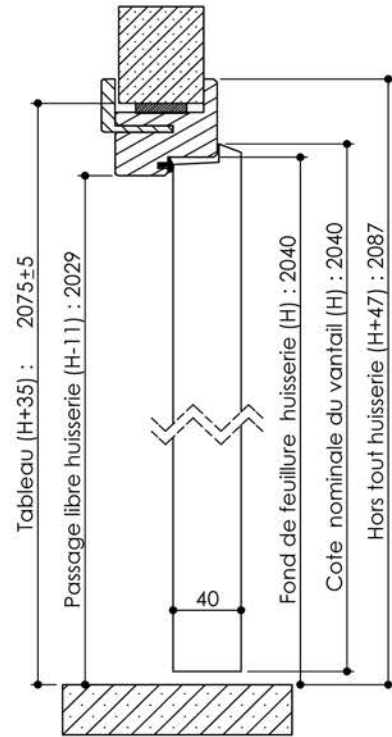
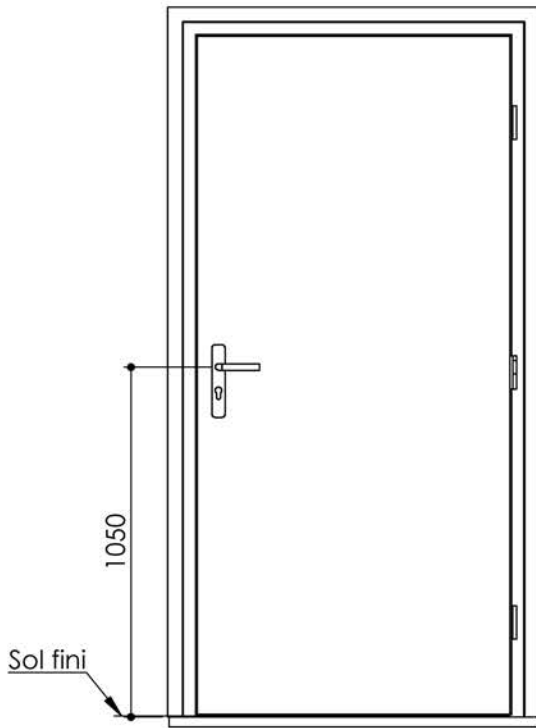
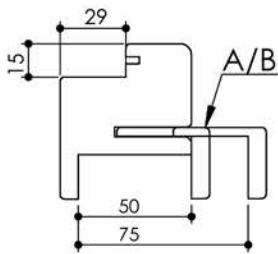
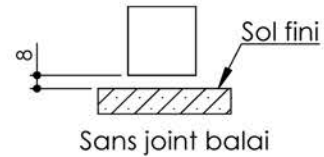

Huisserie isophonique



Tableau (L+48) : 978 ±10
 Passage libre huisserie (L-40) : 890
 Passage libre vantail (L- 45) : 885
 Fond de feuillure huisserie (L-18) : 912
 Cote nominale du vantail (L) : 930
 Hors-tout huisserie (L+76) : 1006



PB-31-1V 01/07/2019

Plan PB-31-B-ICE-2V _ Ind2 : Huisserie bois - Pose fin de chantier - Easy'M-Blanc

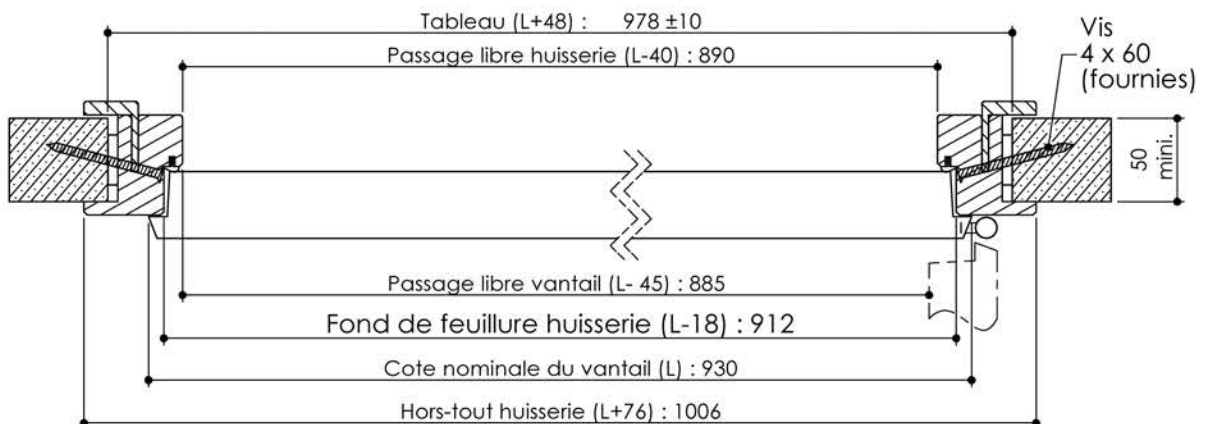
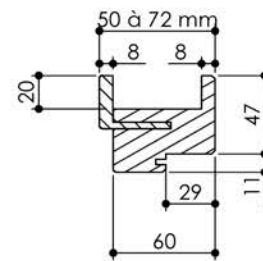
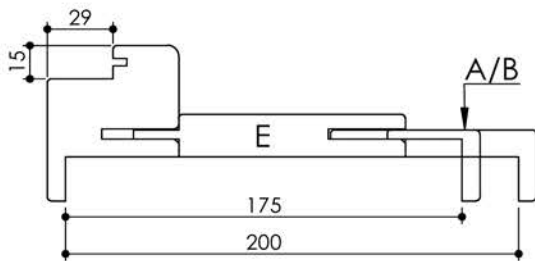
Gamme Porte de Communication

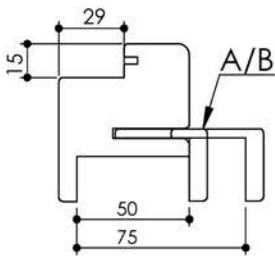
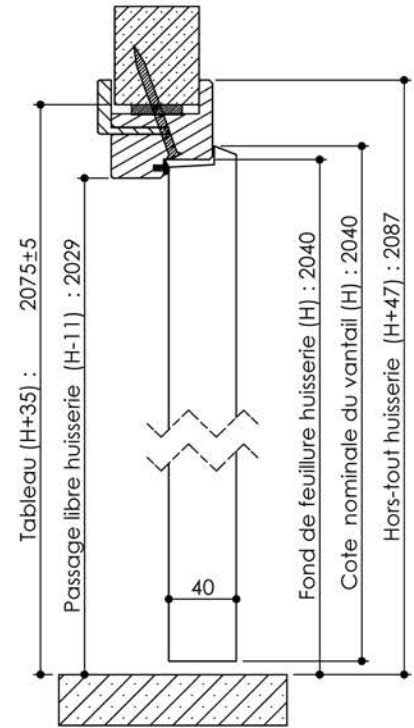
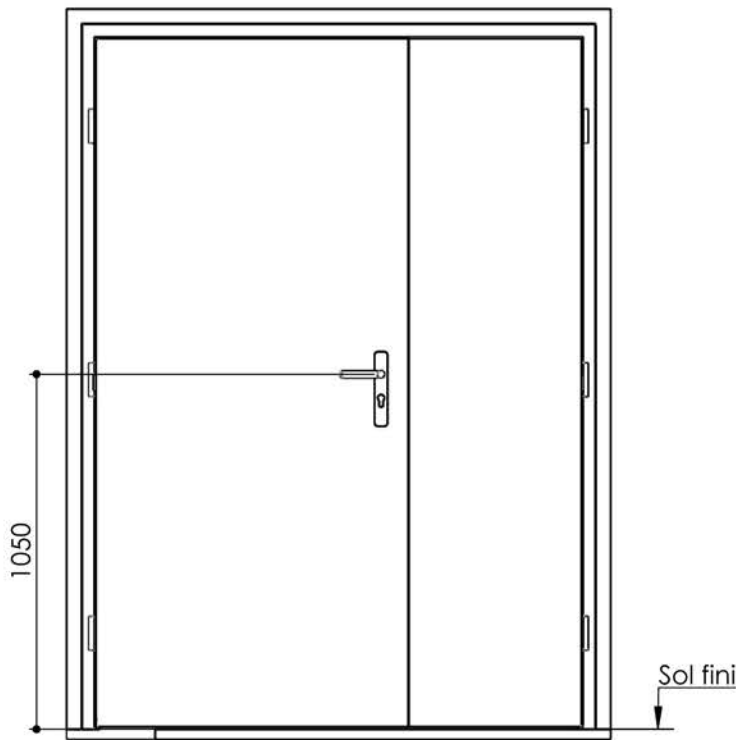

Kit	Epaisseur cloison	Epaisseur cloison avec extenseur E
A	de 50 à 75	de 150 à 175
B	de 75 à 100	de 175 à 200

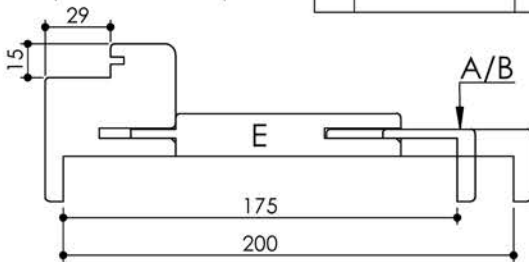

Variante bas de porte

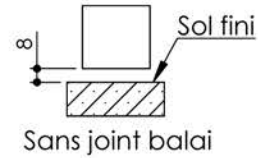

Huisserie isophonique

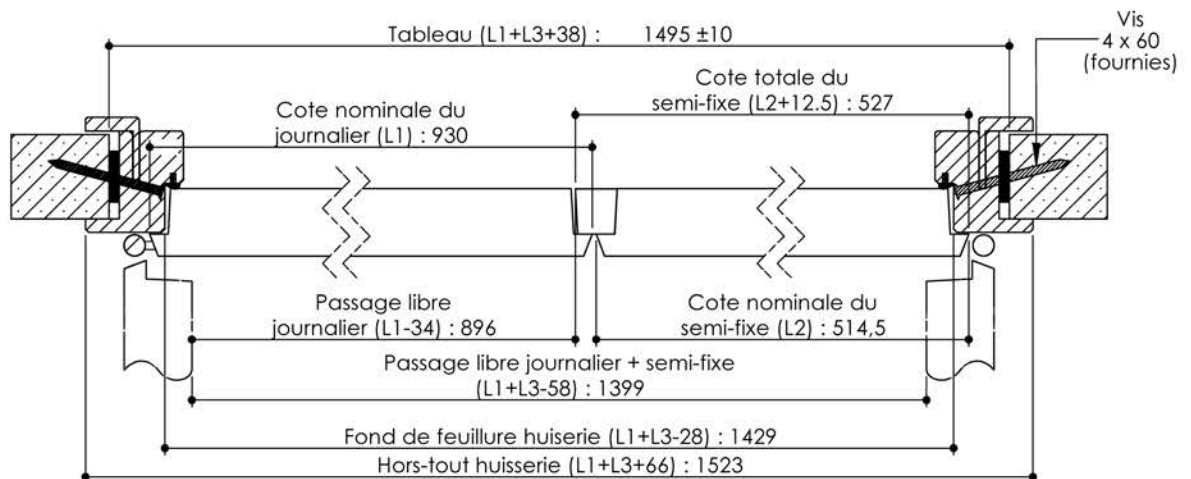
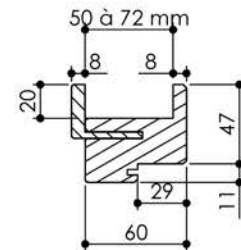

PB-31-ICE-2V 01/07/2019