

Plan PB-7-1V - Ind4 : Huisserie bois -

Pose en tableau

Gamme Porte de Communication

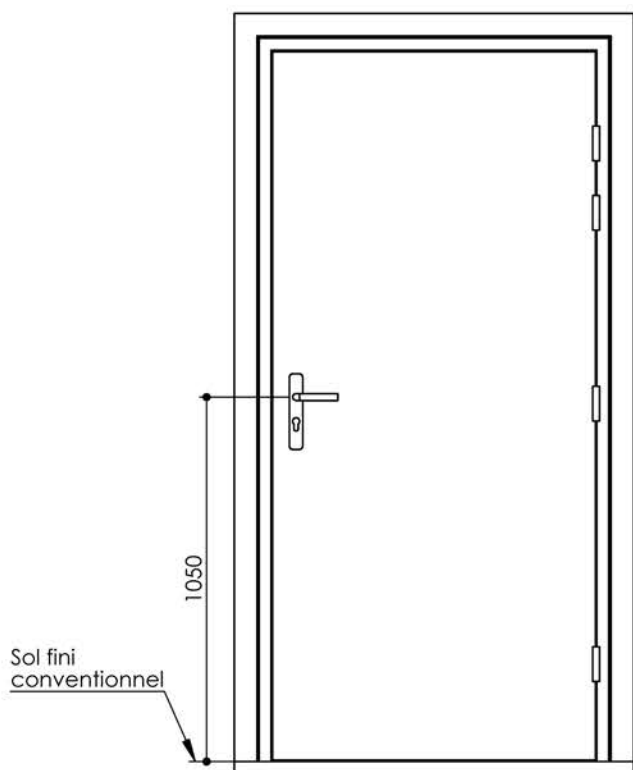

Huisserie non isophonique

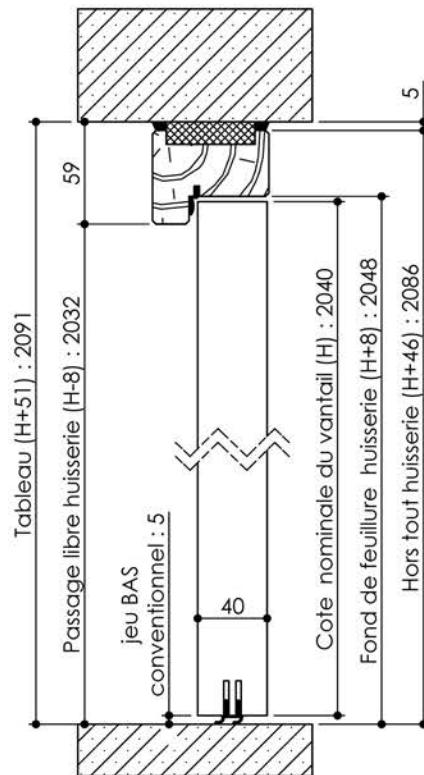

Huisserie isophonique

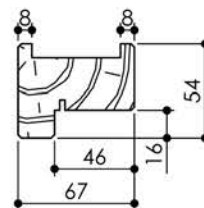
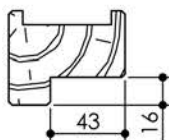

Variantes bas de porte

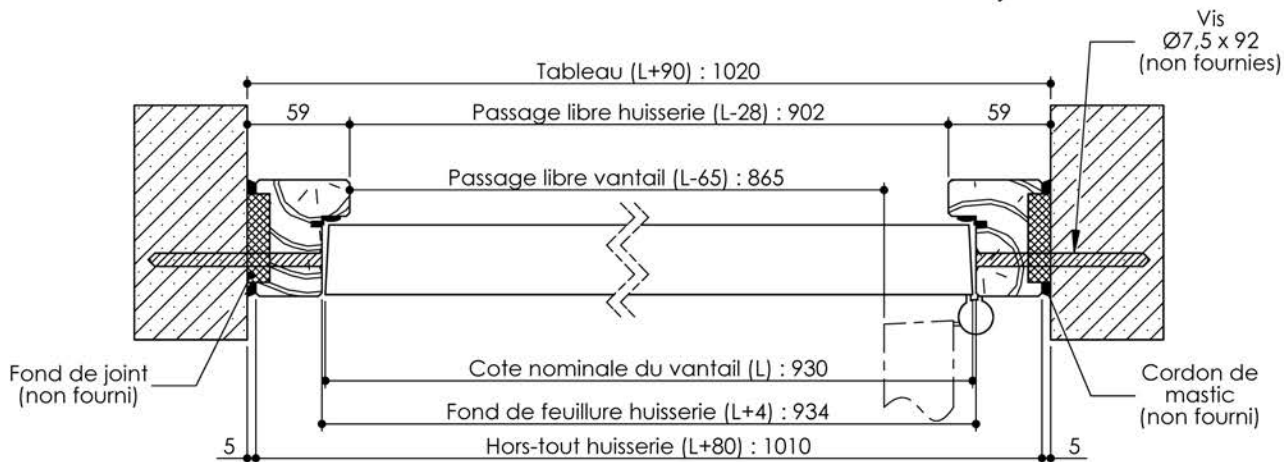
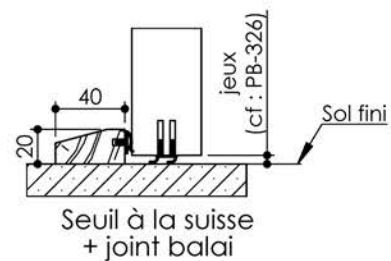
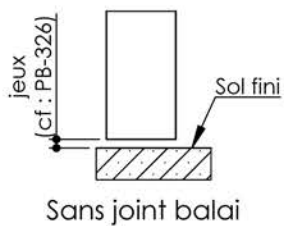
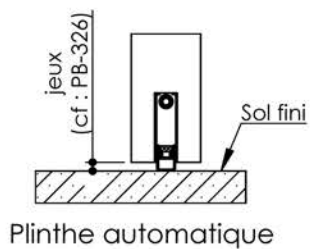

PB-7-1V 09/12/2021

Plan PB-7-2V - Ind5 : Huisserie bois -

Pose en tableau

Gamme Porte de Communication

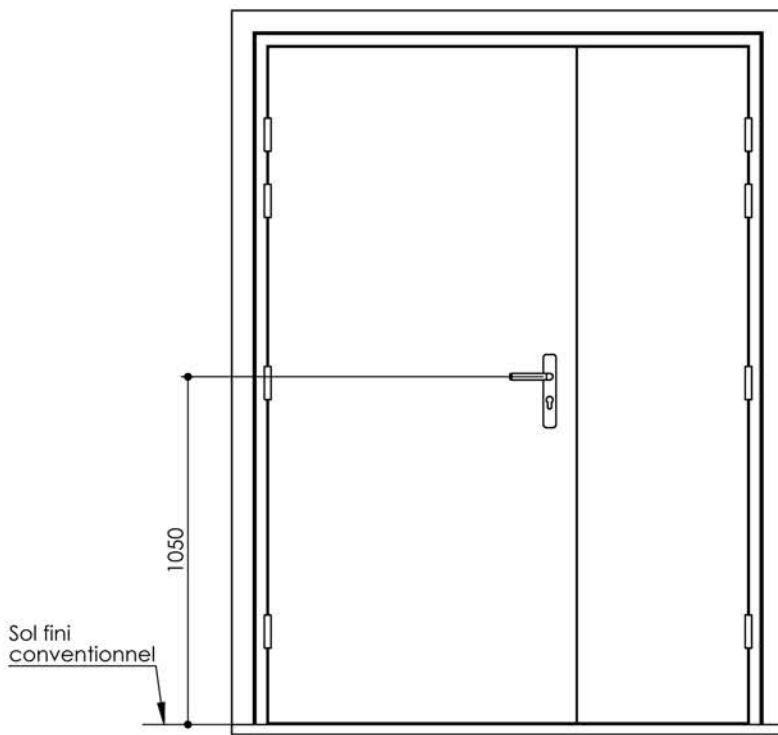

Huisserie non isophonique

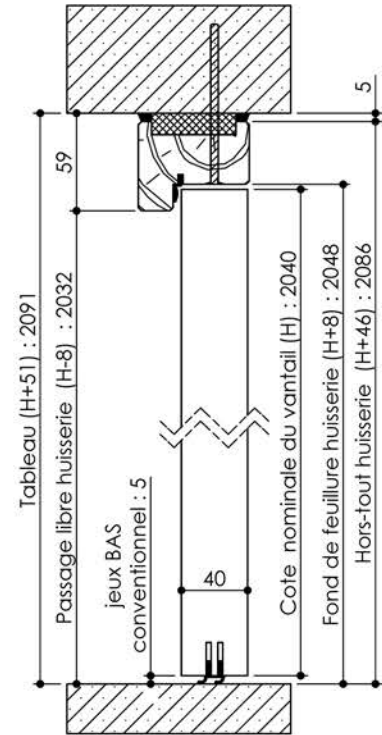

Huisserie isophonique

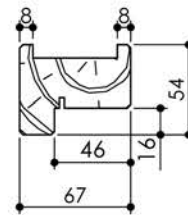
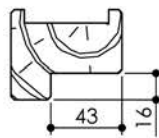

Variantes bas de porte

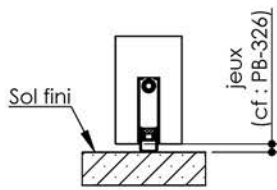

Plinthe automatique

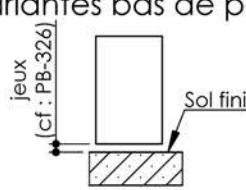

Sans joint balai

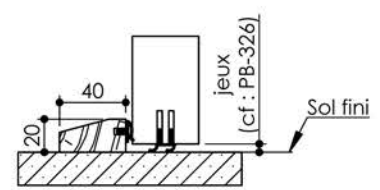

Seuil à la suisse + joint balai

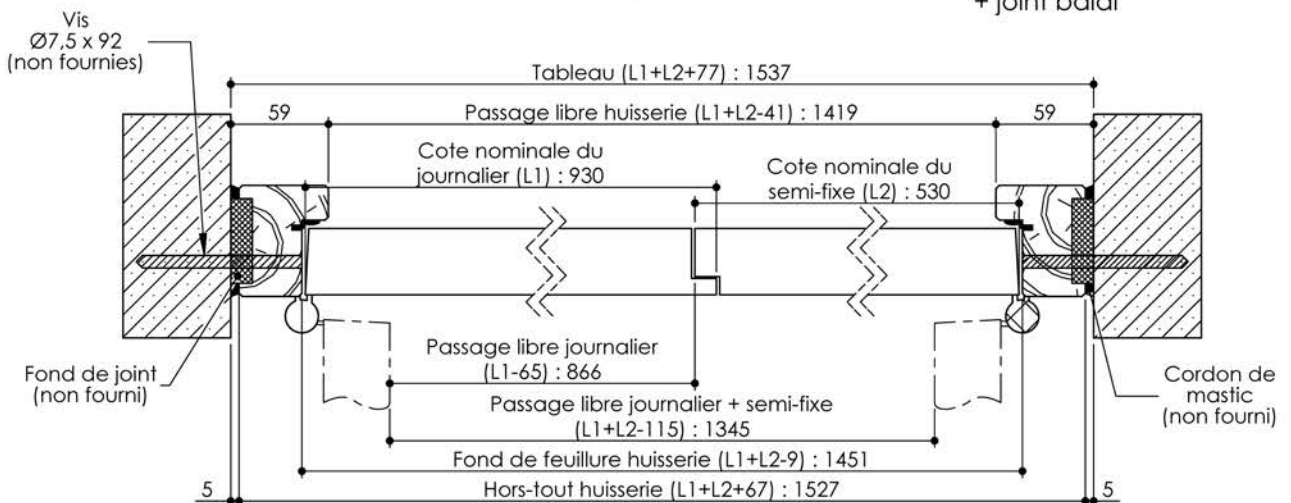

PB-7-2V 09/12/2021