

# Plan PB-66-1V \_ Ind2 : Huisserie bois - Pose en tableau

Gamme Porte EI30 Acoustique

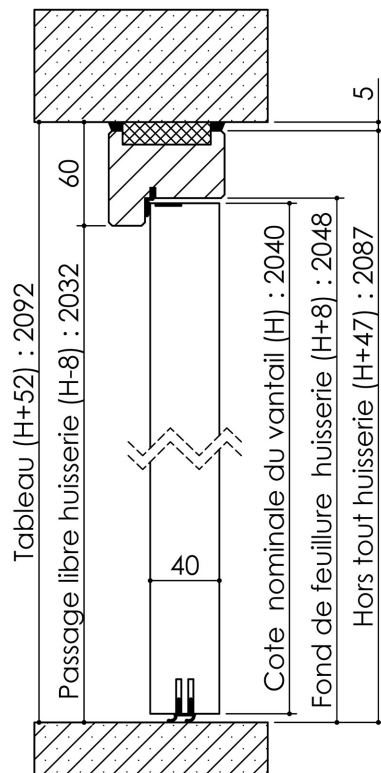

## Variante d'étanchéité

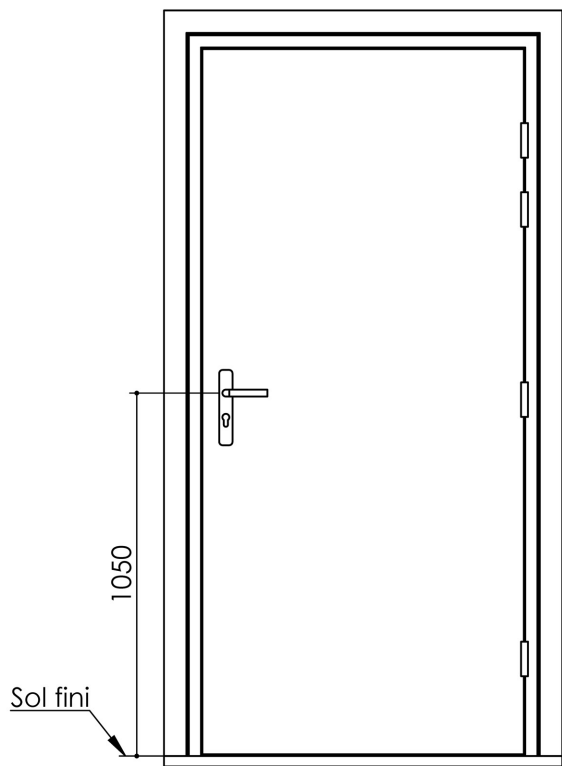
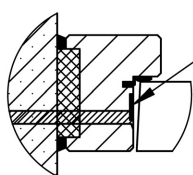

Etanchéité EI30  
Joint intumescent  
fourni posé  
sur l'huisserie

## Huisserie isophonique

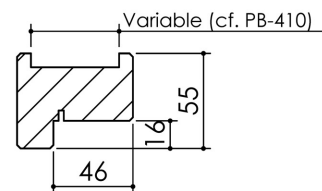

## Variantes bas de porte

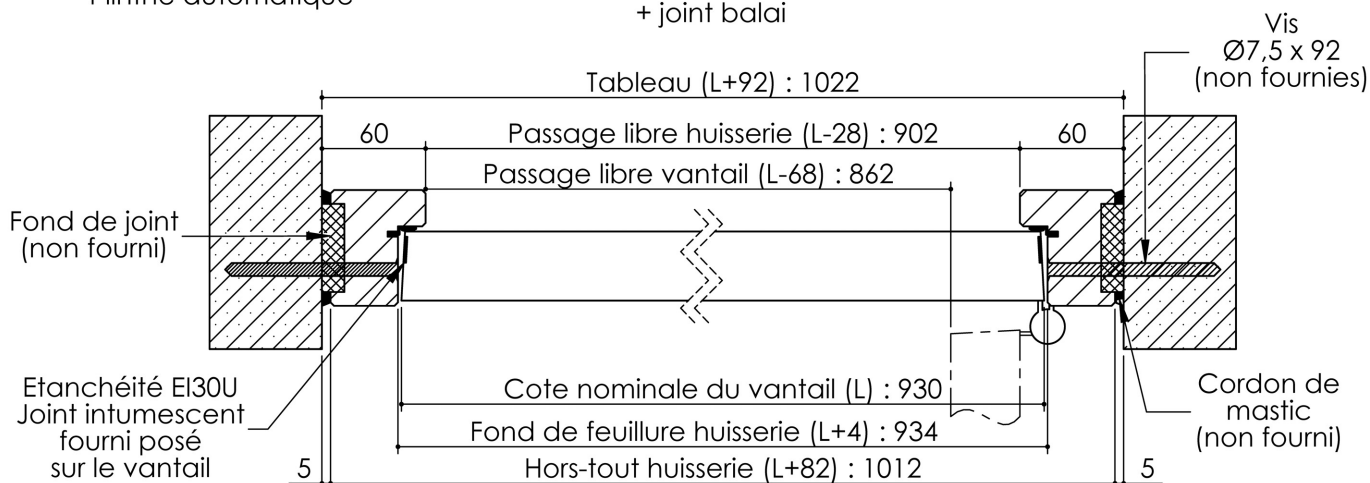
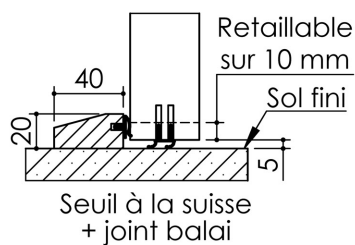
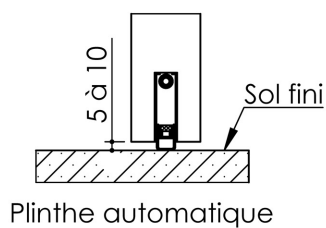

Cahier technique

# Plan PB-66-2V \_ Ind3 : Huisserie bois - Pose en tableau

Gamme Porte EI30 Acoustique

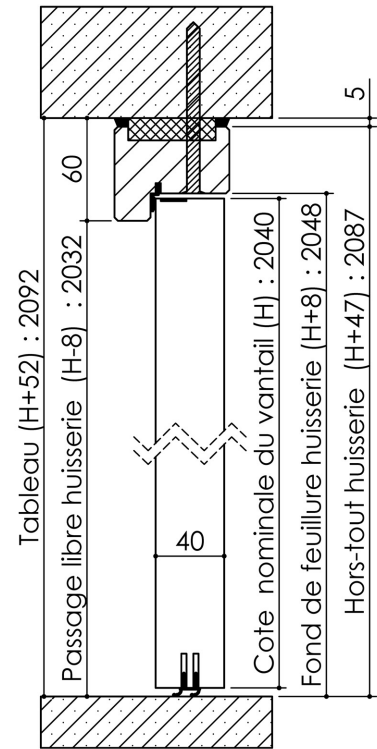
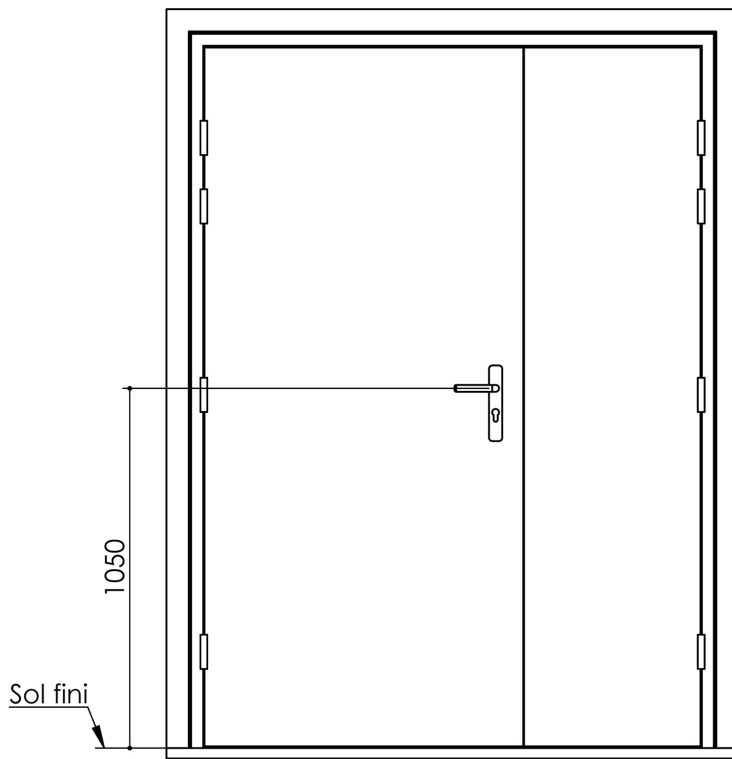

Variante d'étanchéité

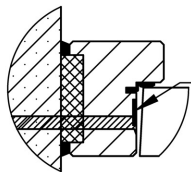

Etanchéité EI30  
Joint intumescent  
fourni posé  
sur l'huisserie

Huisserie isophonique

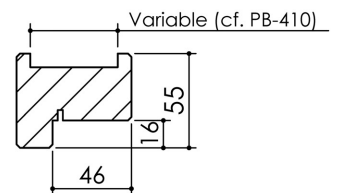

Variantes bas de porte

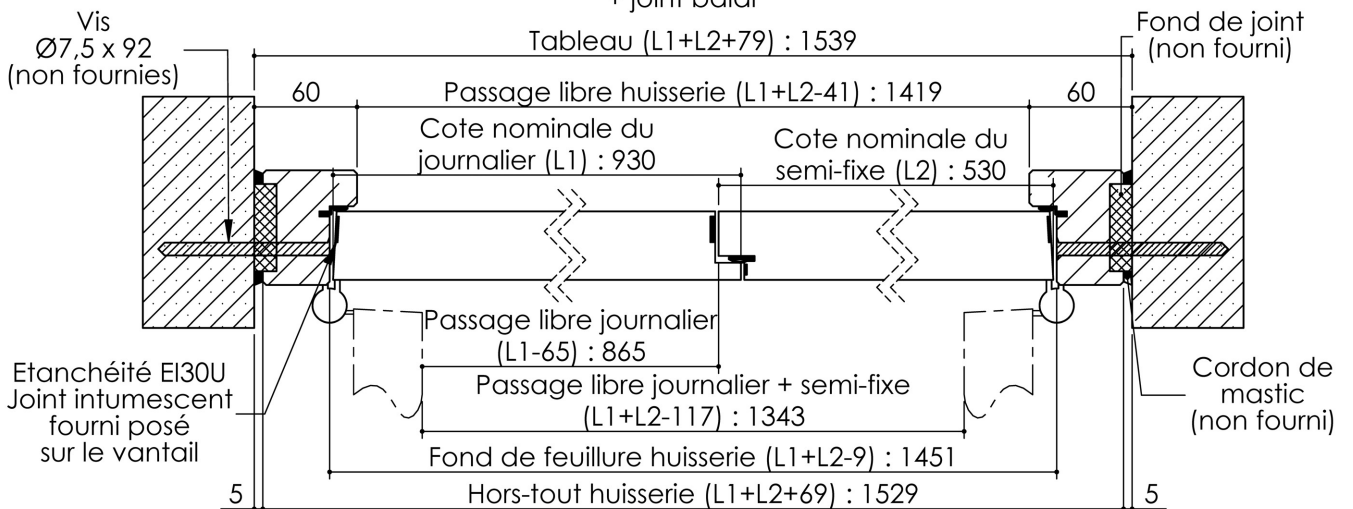
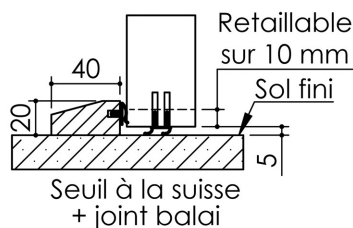
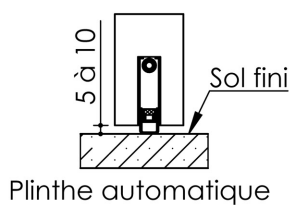

Cahier technique