

# Plan PB-4-1V \_ Ind2 : Huisserie bois - Pose scellée

Gamme Porte de Communication

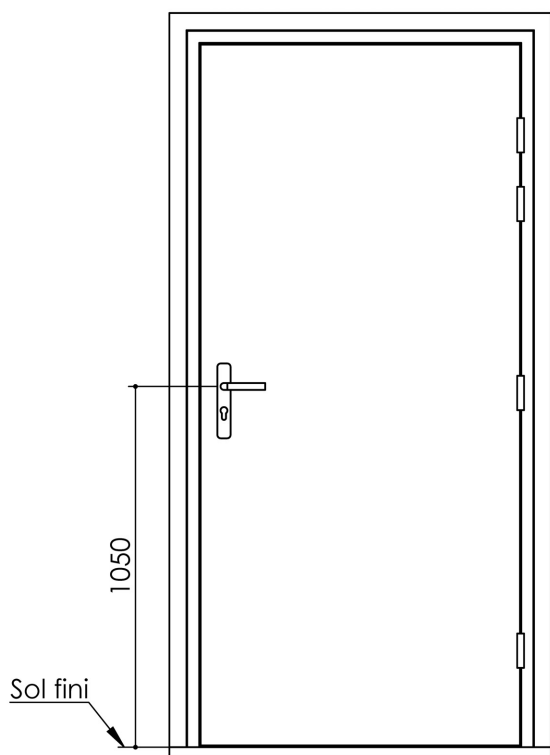

Huisserie non isophonique

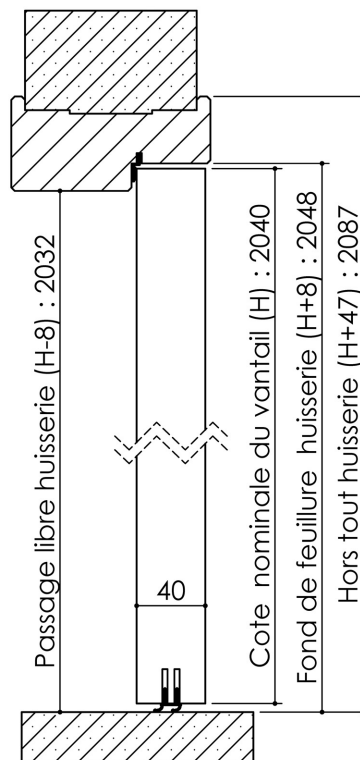
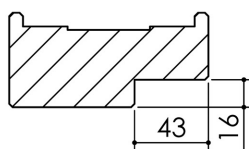

Huisserie isophonique

Variable (cf. PB-410)

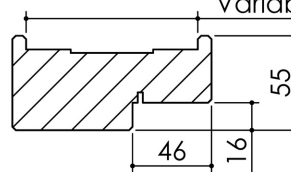

## Variantes bas de porte

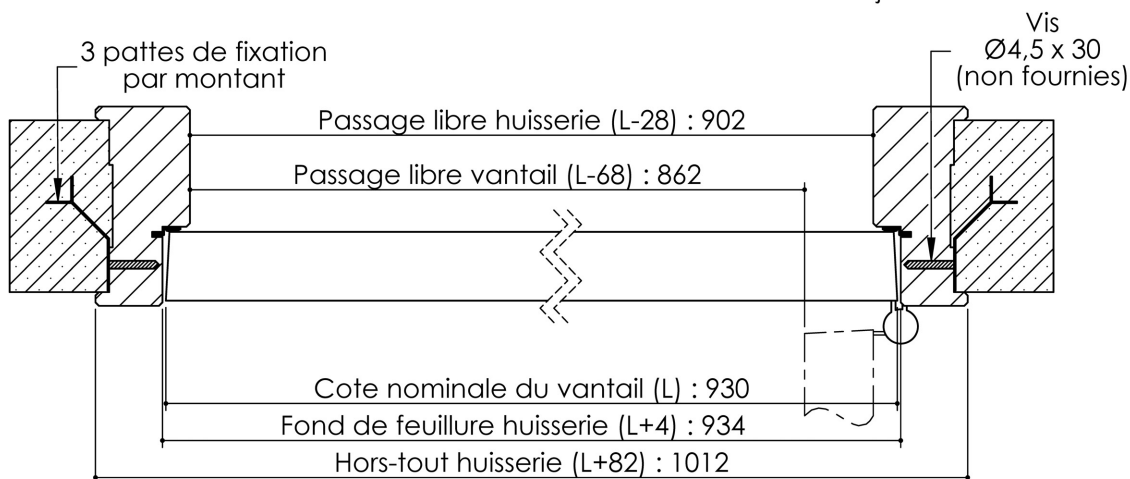
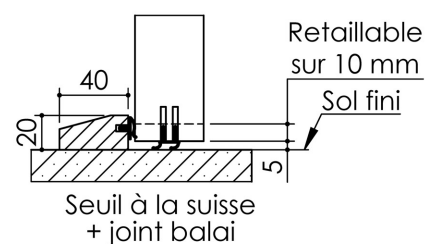
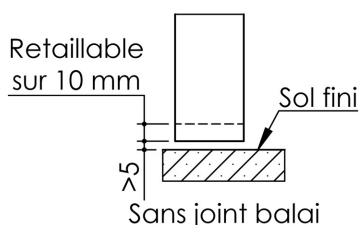
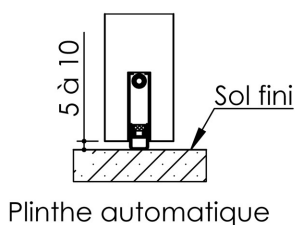

# Plan PB-4-2V \_ Ind3 : Huisserie bois - Pose scellée

Gamme Porte de Communication

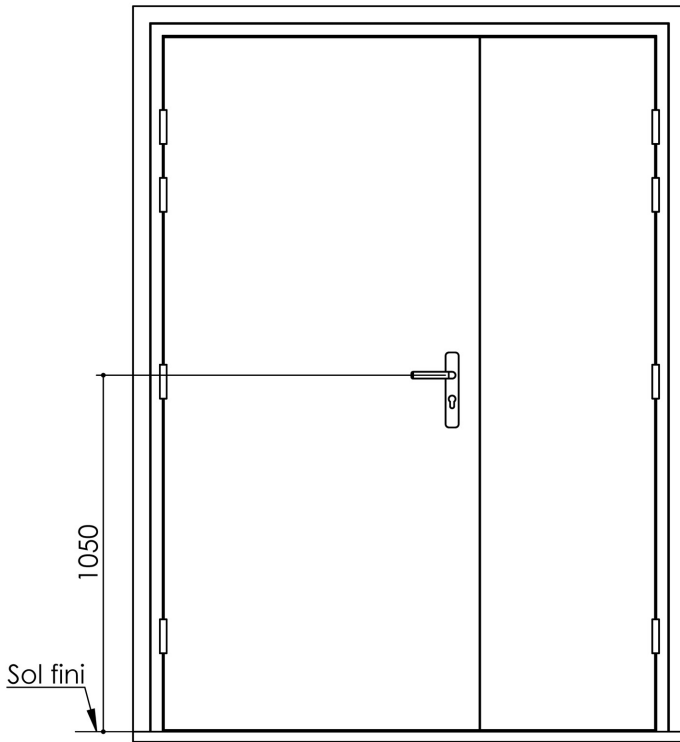

Huisserie non isophonique

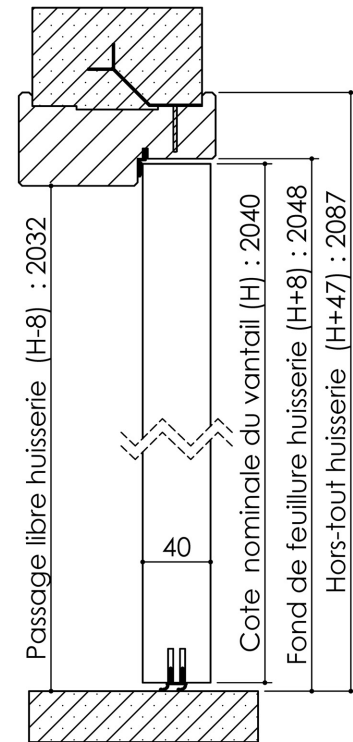
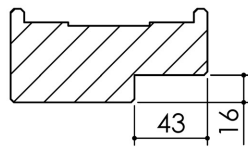

Huisserie isophonique

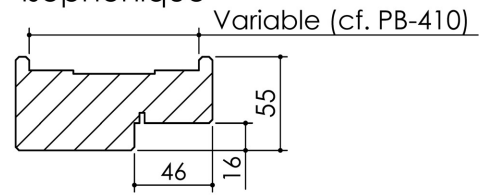

## Variantes bas de porte

