

Plan PB-32-1V _ Ind5 : Huisserie bois - Pose fin de chantier - Easy bois

Gamme Porte de Communication

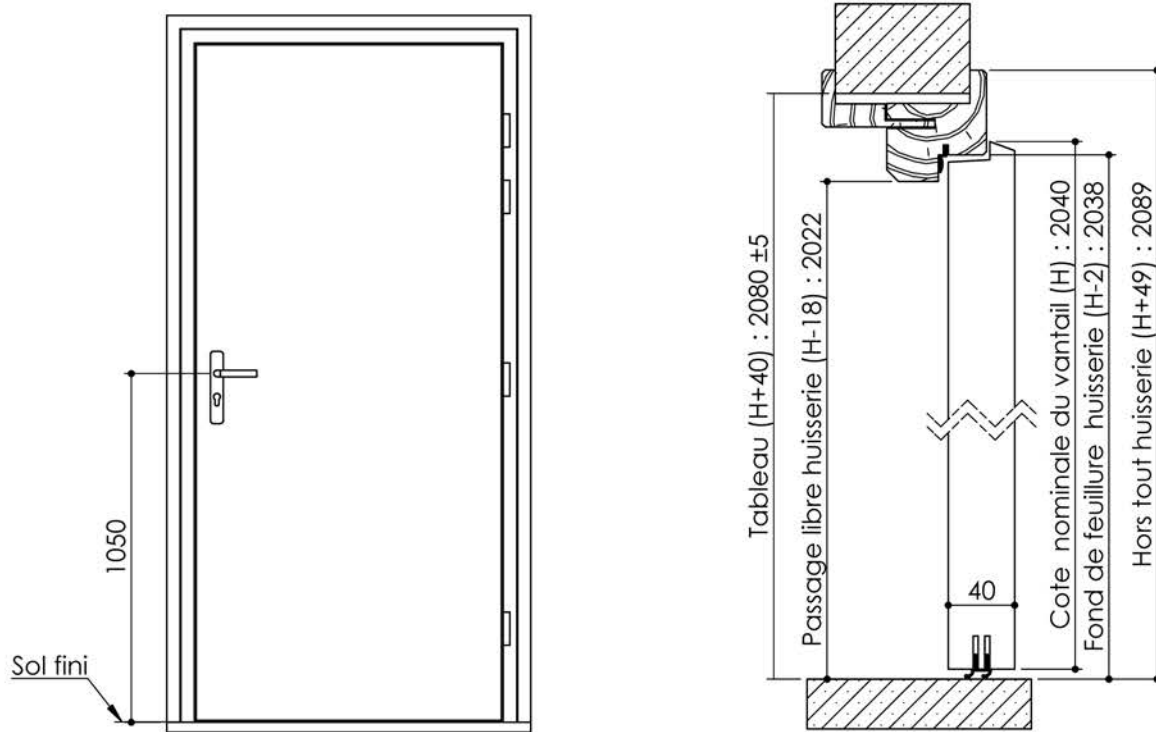

Extension CC L
cloison 78 à 100 mm

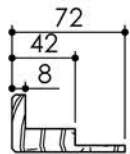

Extension CC S+
cloison 50 à 78 mm
(depuis 03/19)

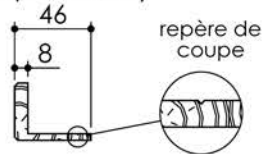

Huisserie isophonique

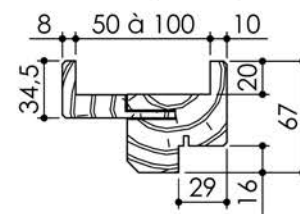

Variantes bas de porte

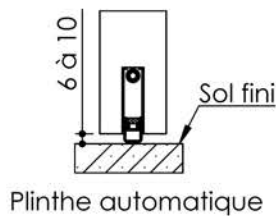

Plinthe automatique

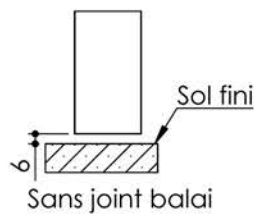

Sans joint balai

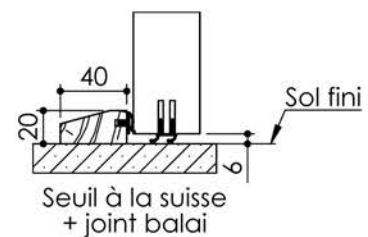

Seuil à la suisse
+ joint balai

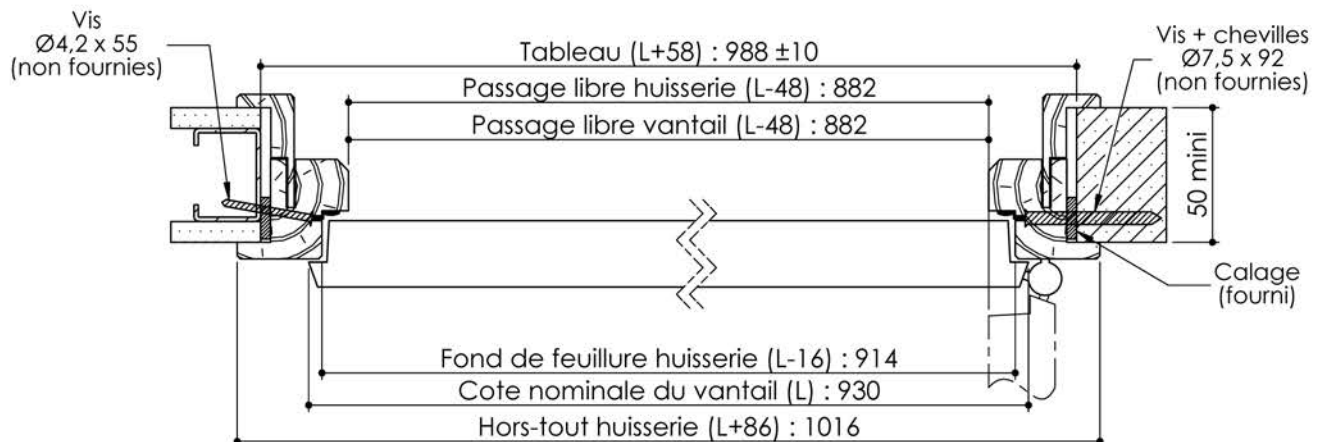

KEYOR

PB-32-1V 06/11/2020

Plan non contractuel, Keyor se réserve le droit de modifier ce plan pour des raisons industrielles

Plan PB-32-2V _ Ind5 : Huisserie bois - Pose fin de chantier - Easy bois

Gamme Porte de Communication

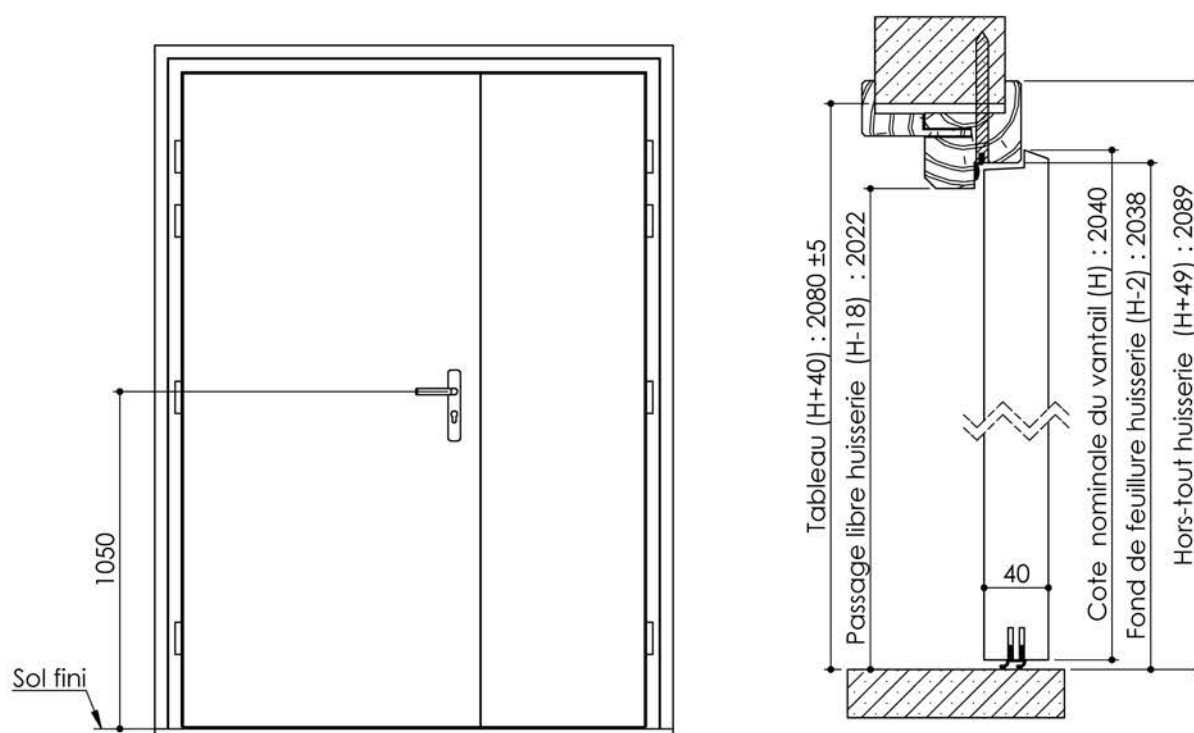

Extension CC L
cloison 78 à 100 mm

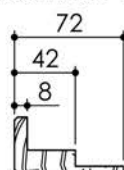

Extension CC S+
cloison 50 à 78 mm
(depuis 03/19)

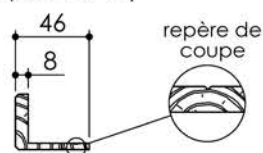

Huisserie isophonique

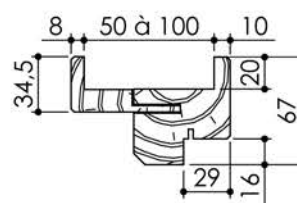

Variantes bas de porte

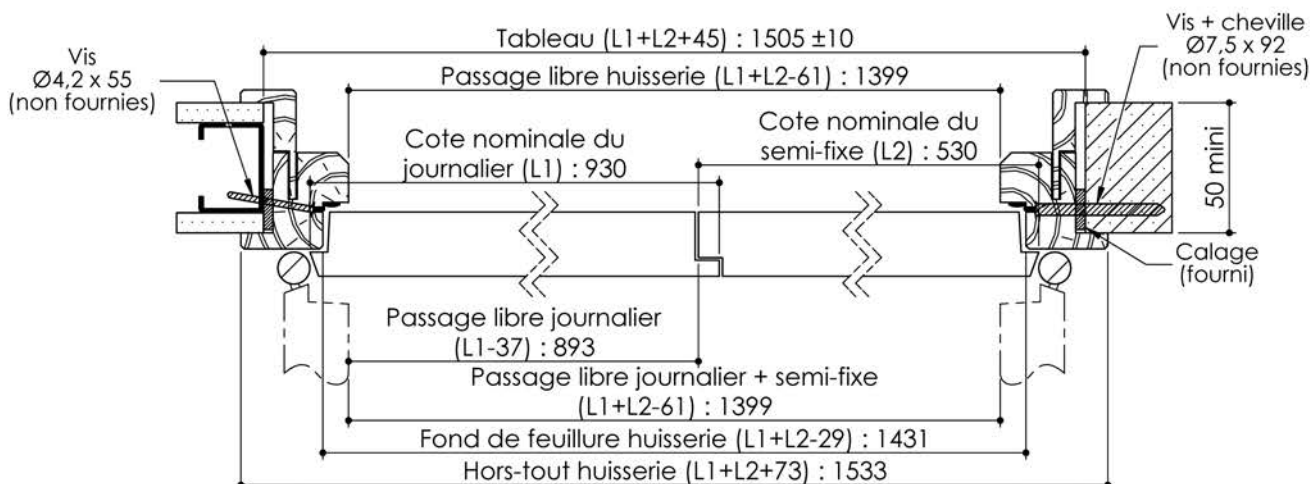
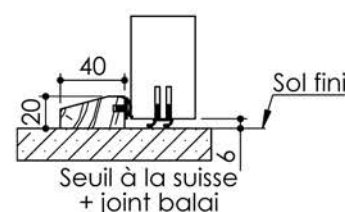
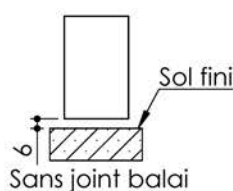
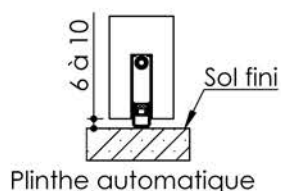

KEYOR

PB-32-2V 06/11/2020

Plan non contractuel, Keyor se réserve le droit de modifier ce plan pour des raisons industrielles

Plan PB-13-1V _ Ind5 : Huisserie bois - Pose fin de chantier - Easy bois

Gamme Porte de Communication

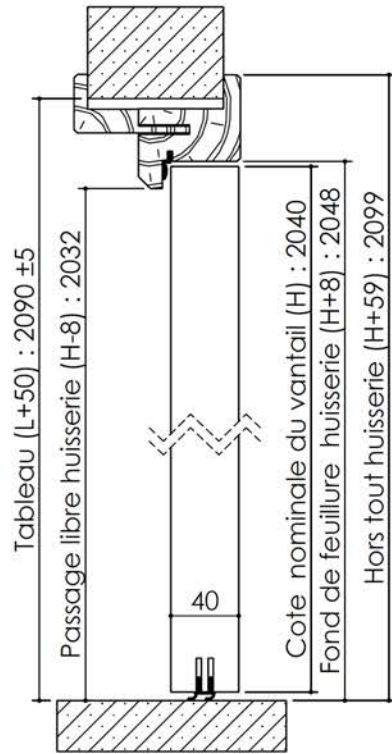
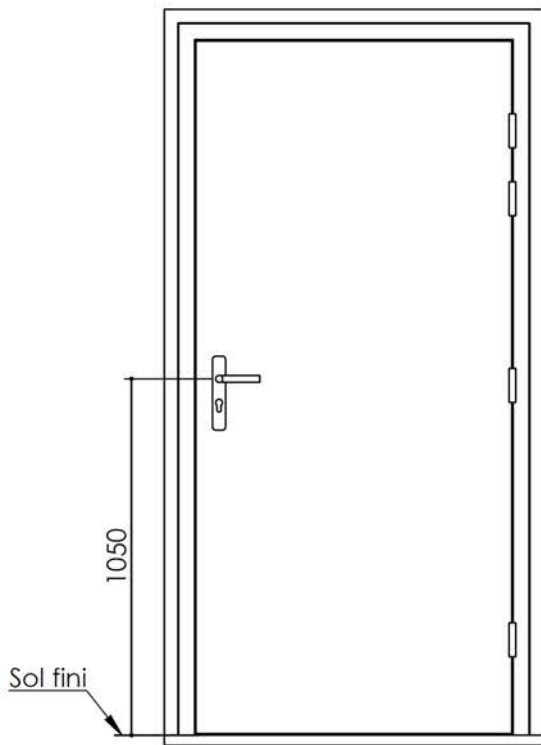

Extension CC L
cloison 78 à 100 mm

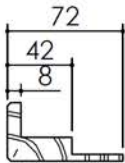

Extension CC S+
cloison 50 à 78 mm
(depuis 03/19)

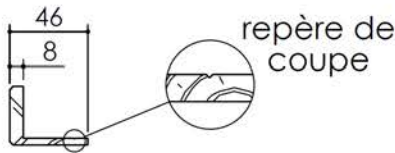

Huisserie isophonique

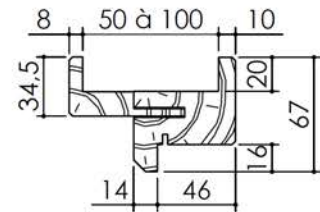

Variantes bas de porte

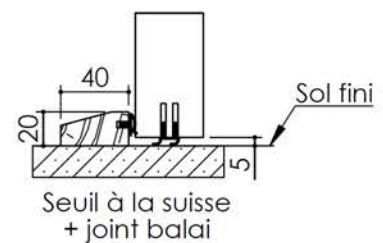
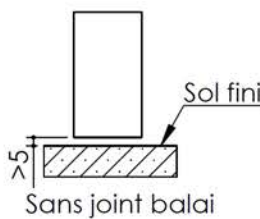
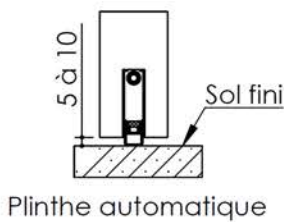

Vis
Ø4,2 x 55
(non fournies)

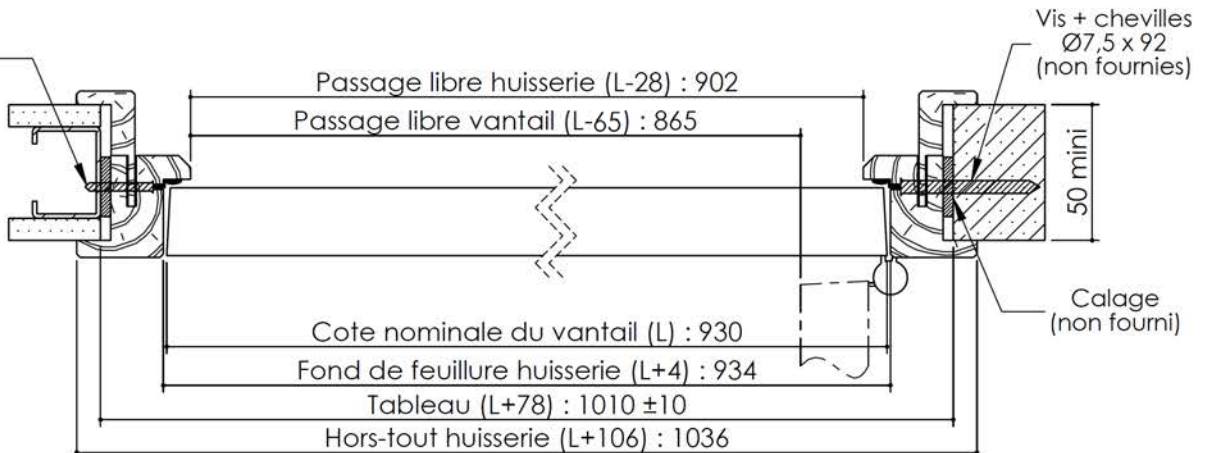

KEYOR

PB-13-1V 01/07/2019

Plan non contractuel, Keyor se réserve le droit de modifier ce plan pour des raisons industrielles

Plan PB-13-2V _ Ind5 : Huisserie bois - Pose fin de chantier - Easy bois

Gamme Porte de Communication

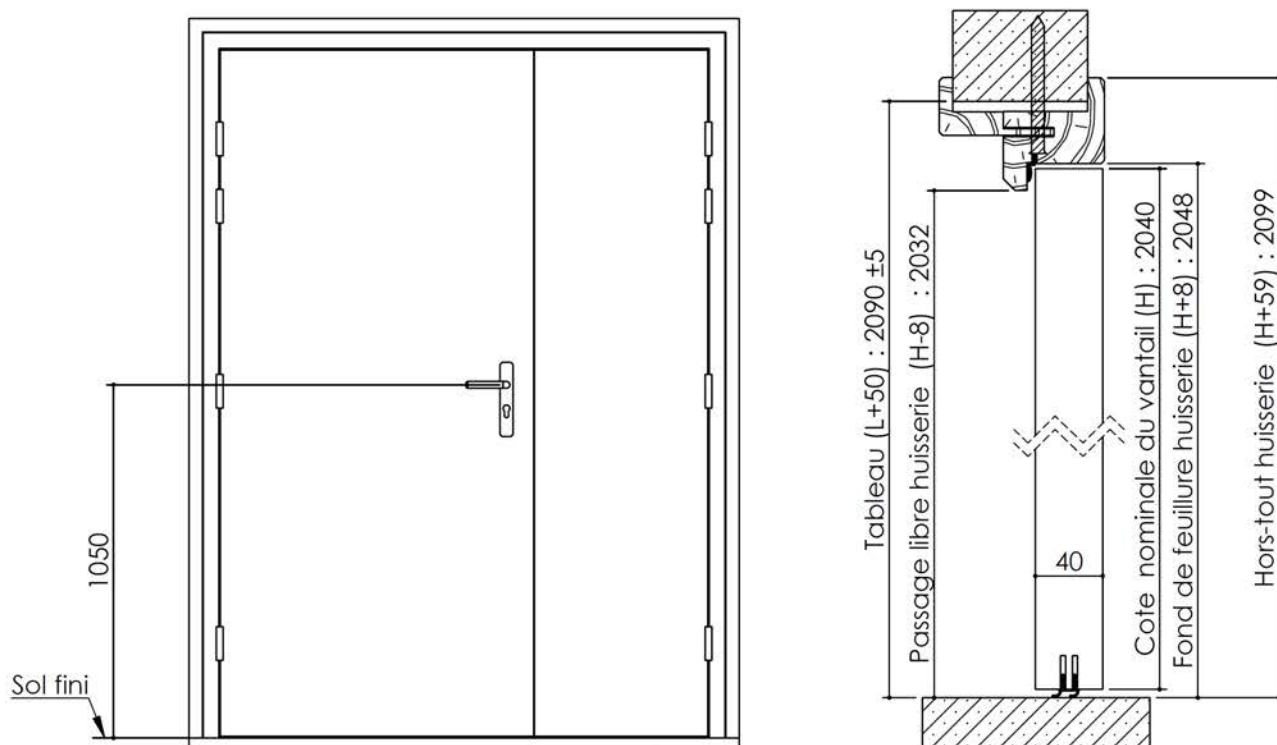

Extension CC L
cloison 78 à 100 mm

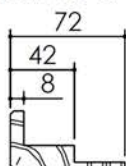

Extension CC S+
cloison 50 à 78 mm
(depuis 03/19)

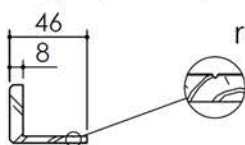

Huisserie isophonique

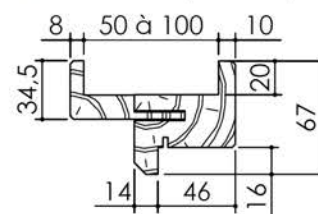

Variantes bas de porte

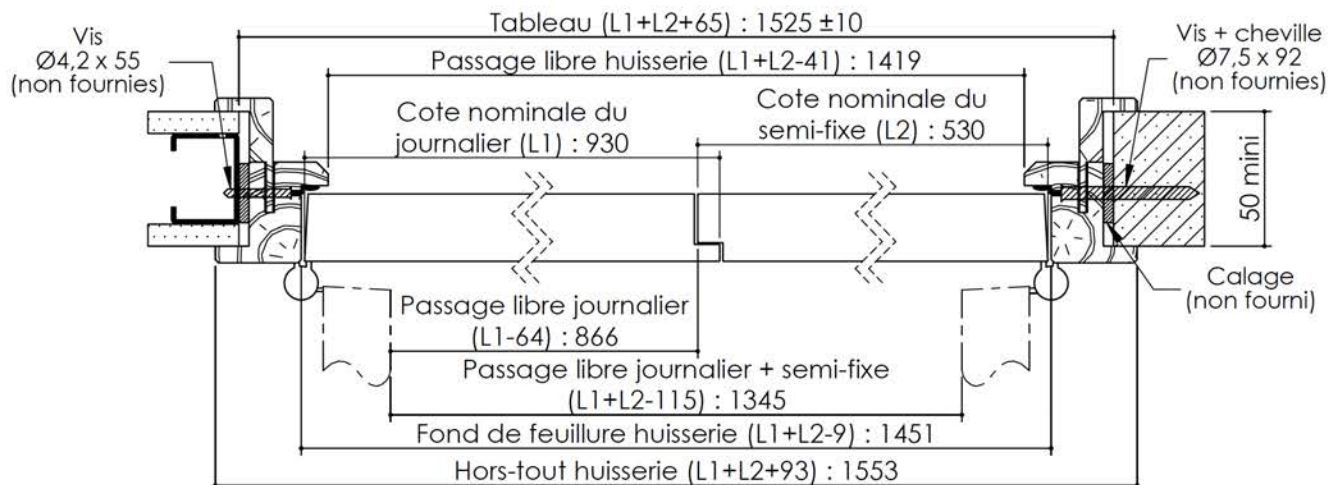
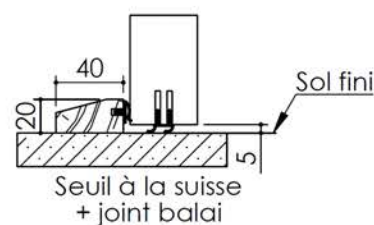
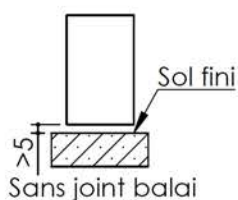
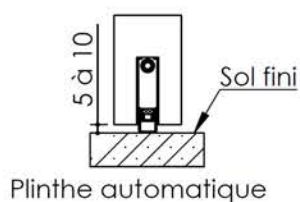

PB-13-2V 01/07/2019