

# Plan PB-61-1V \_ Ind3 : Bâti bois - Pose scellée

Gamme Porte EI30 Acoustique

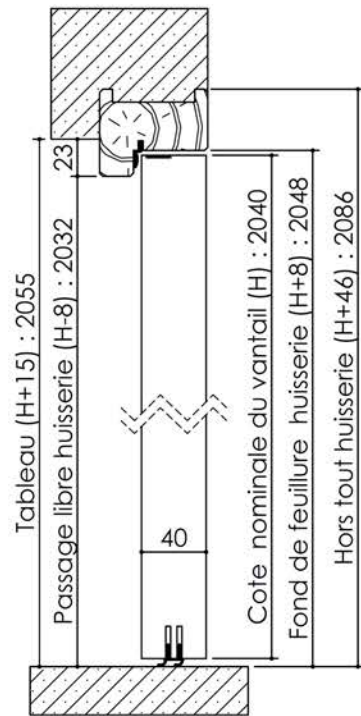

## Variante d'étanchéité

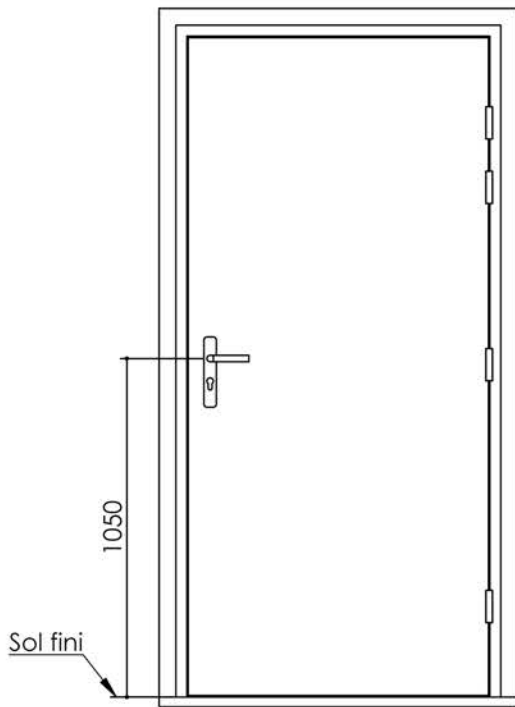
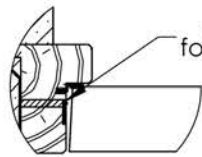

Etanchéité EI30  
Joint intumescent  
fourni posé en rainure  
dans l'huisserie

## Huisserie isophonique

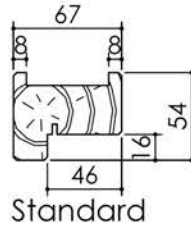

Standard

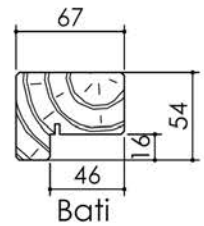

Bati

## Variantes bas de porte

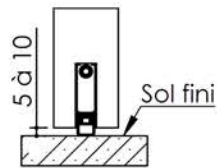

Plinthe automatique

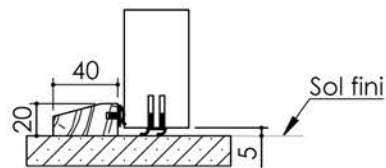

Seuil à la suisse  
+ joint balai

3 pattes de fixation  
par montant  
(non fournies)

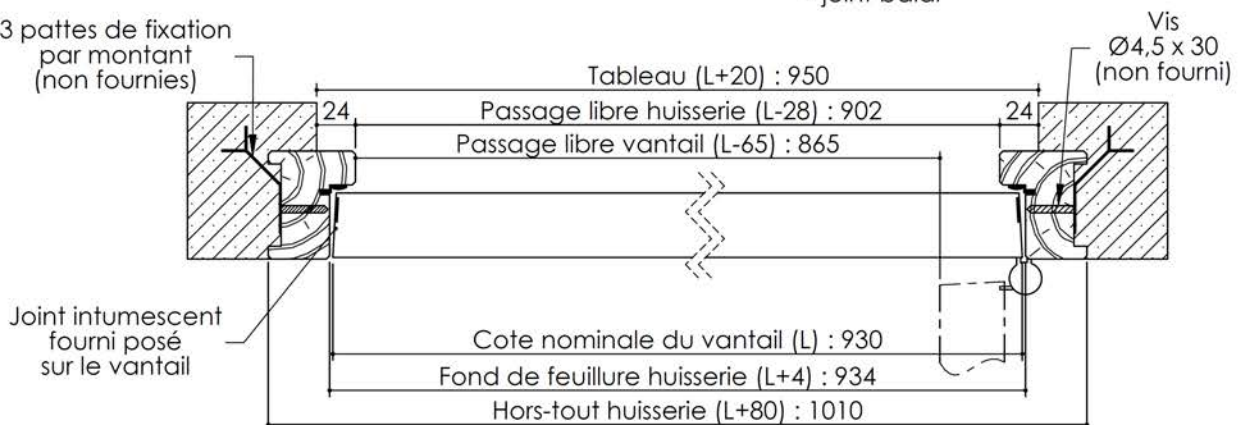

**KEYOR**

PB-61-1V 01/07/2019

Plan non contractuel, Keyor se réserve le droit de modifier ce plan pour des raisons industrielles

# Plan PB-61-2V \_ Ind4 : Bâti bois - Pose scellée

Gamme Porte EI30 Acoustique

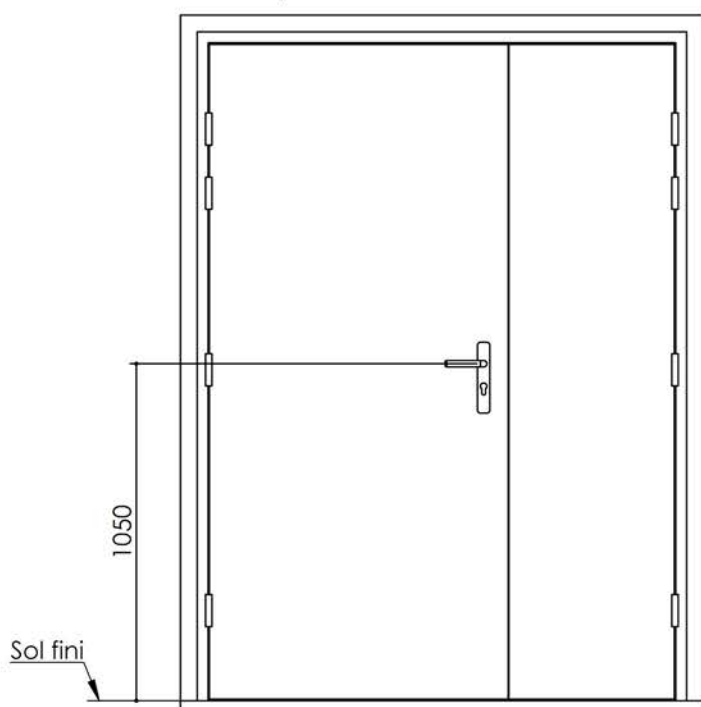

Variante d'étanchéité

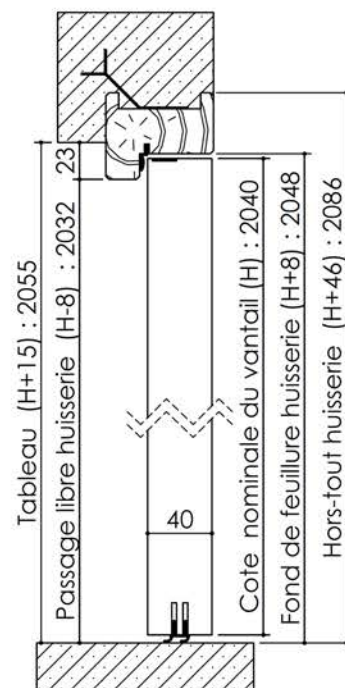

Huissierie isophonique

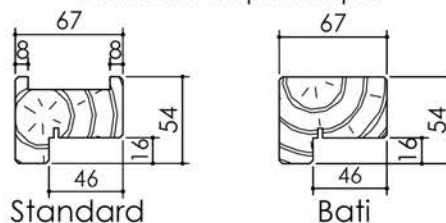

Variantes bas de porte

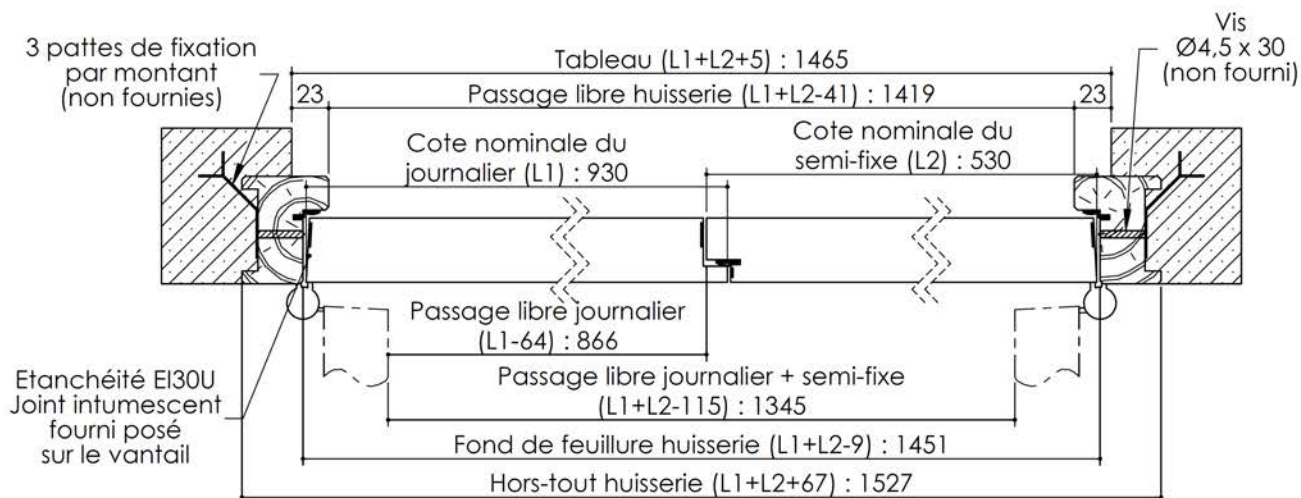
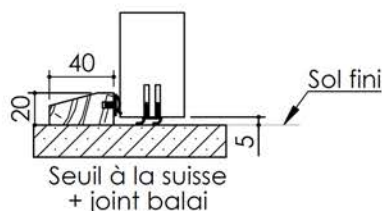
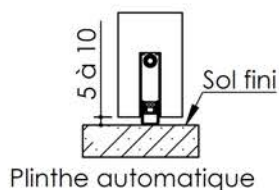

PB-61-2V 01/07/2019