

Plan PB-224-1V _ Ind4 : Huisserie métal - Pose banchée

Gamme Porte feu EI60

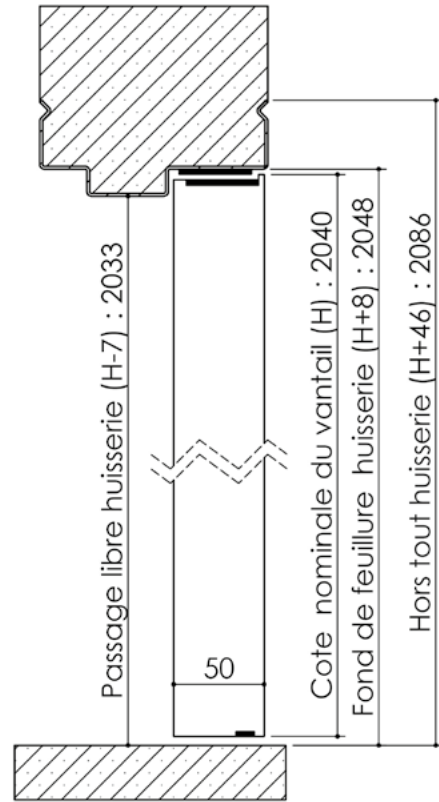

Variante bas de porte

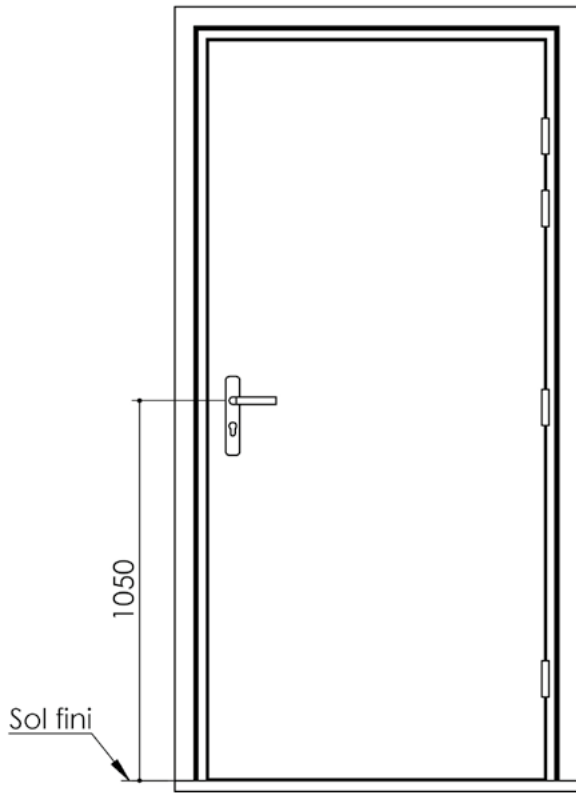
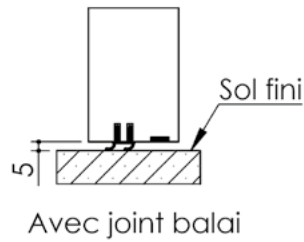

Huisserie non isophonique

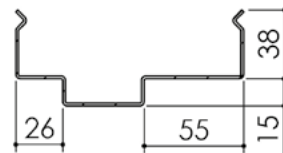

Barettes soudées

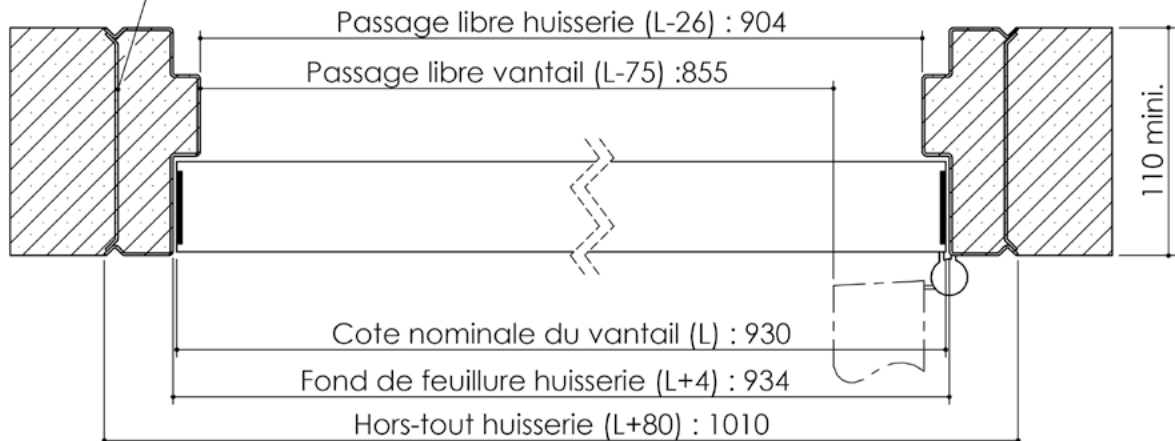

Cahier technique

Plan PB-224-2V-A - Ind5 : Huisserie métal - Pose banchée

Gamme Porte feu EI60 GD (SUPRAFEU GD feuillure centrale de 15).

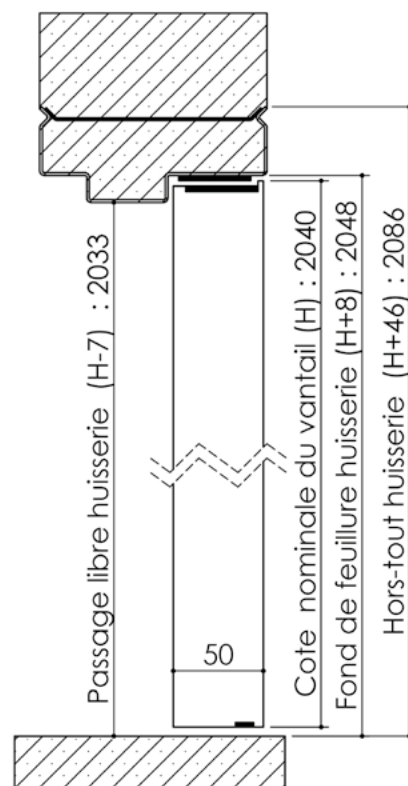
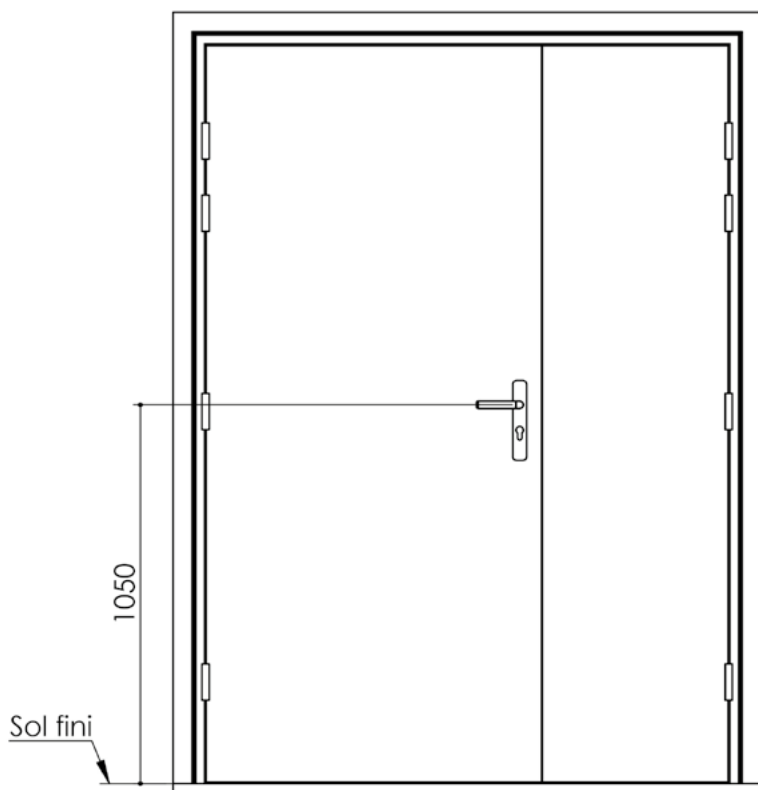

Variante bas de porte

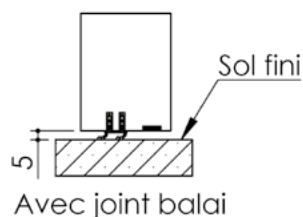

Détail de feuillure centrale de 15

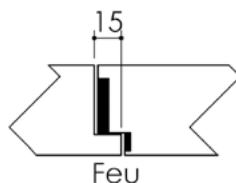

Huisserie non isophonique

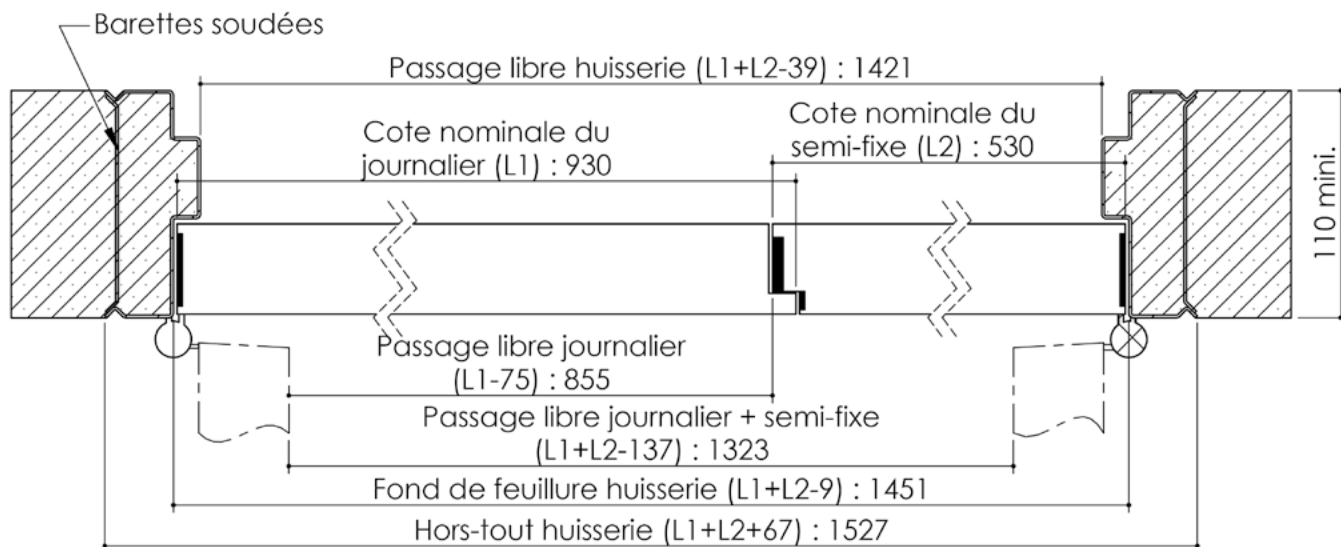
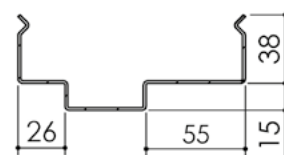

Cahier technique

Plan PB-224-2V-B _ Ind4 : Huisserie métal - Pose banchée

Gamme Porte feu EI60 STD (SUPRAFEU EI60 feuillure centrale de 25).

 Largeur standard en 2V : 935 + 535

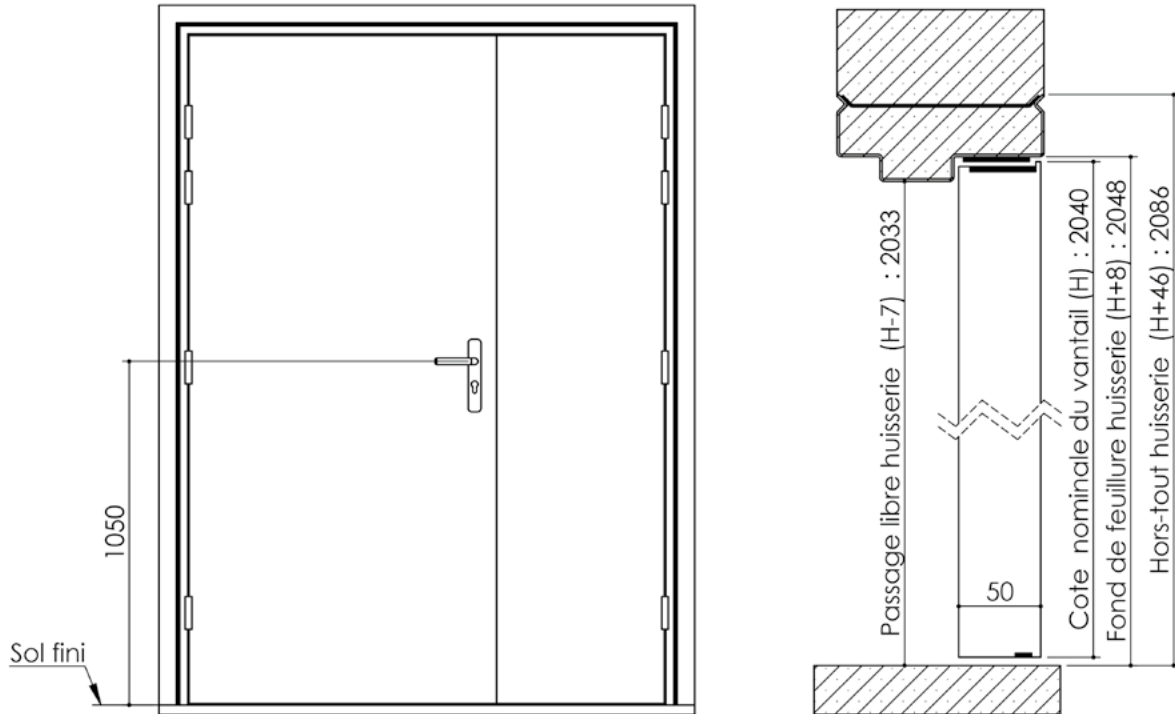

Variante bas de porte

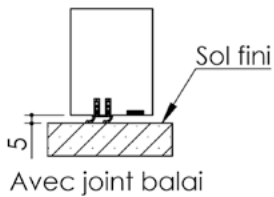

Détail de feuillure centrale de 25

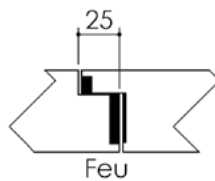

Huisserie non isophonique

