

# Plan PB-9-1V \_ Ind2 : Huisserie bois - Pose sur cloison plaques de plâtre

Gamme Porte de Communication

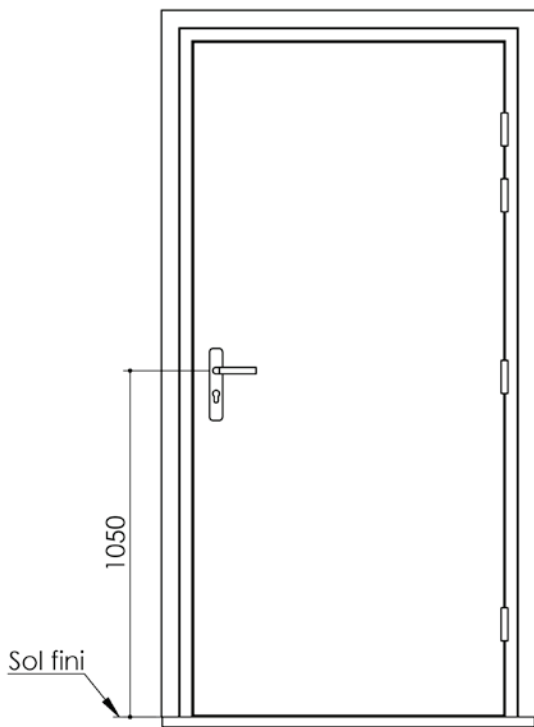

Huisserie non isophonique

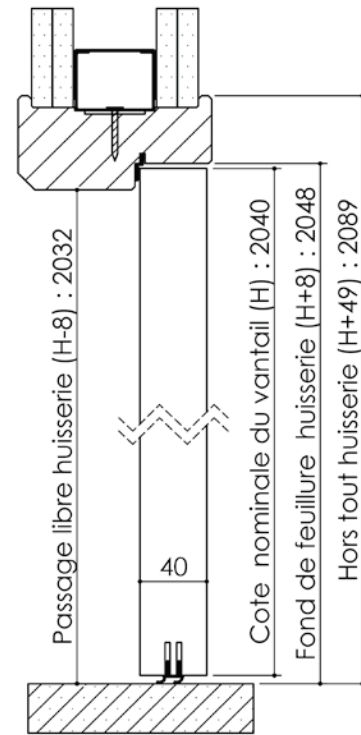
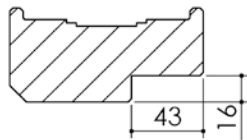

Huisserie isophonique

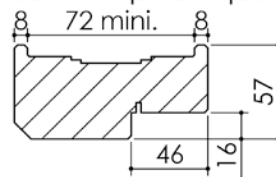

## Variantes bas de porte

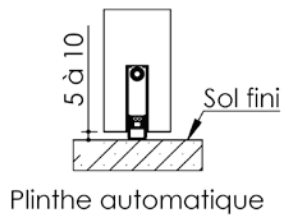

Plinthe automatique

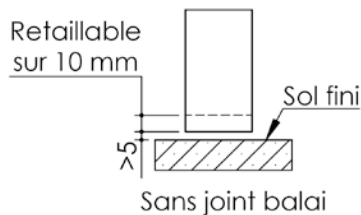

Sans joint balai

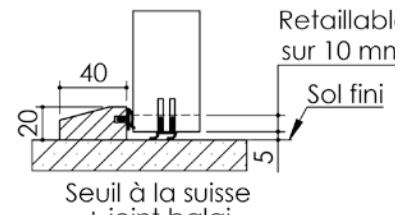

Seuil à la suisse + joint balai

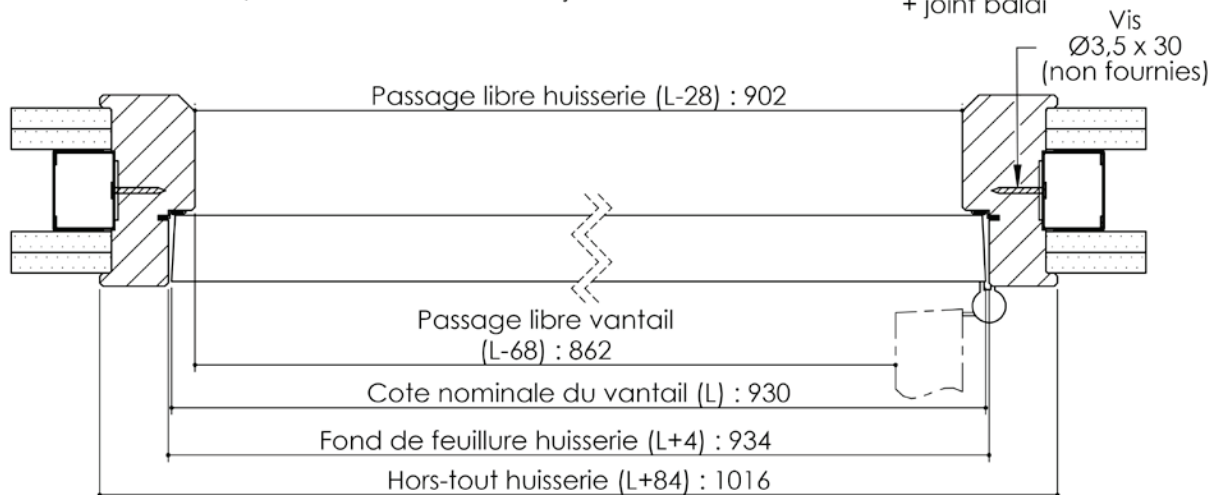

Cahier technique

# Plan PB-28-1V \_ Ind1 : Huisserie bois - Pose sur cloison plaques de plâtre

Gamme Porte de Communication

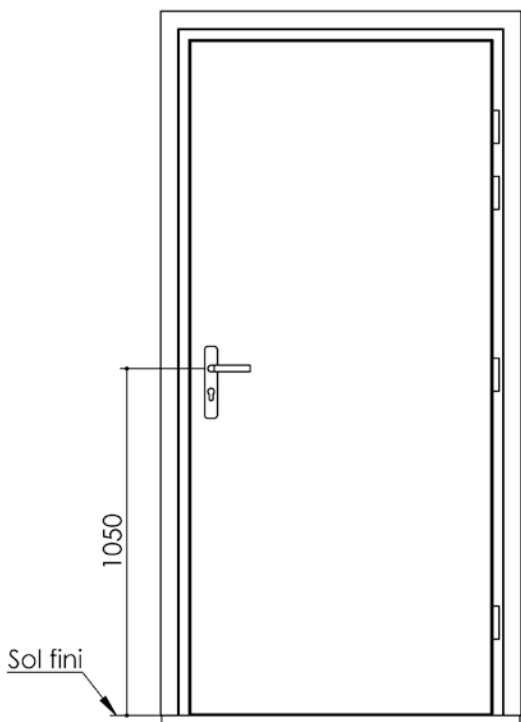

Huisserie non isophonique

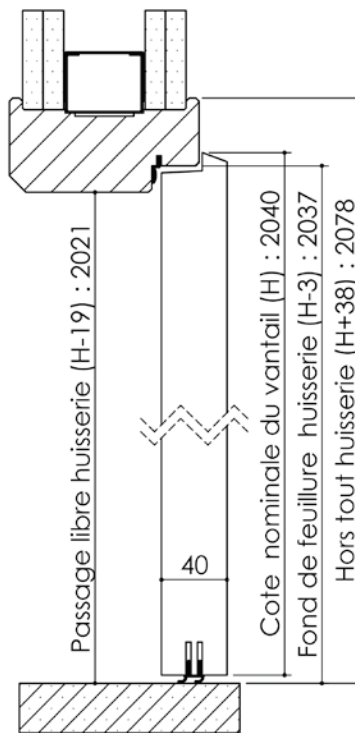

Huisserie isophonique

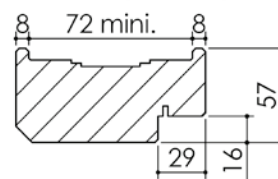
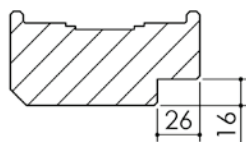

Variantes bas de porte

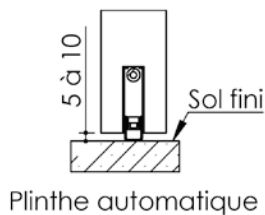

Plinthe automatique

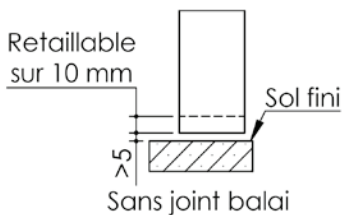

Sans joint balai

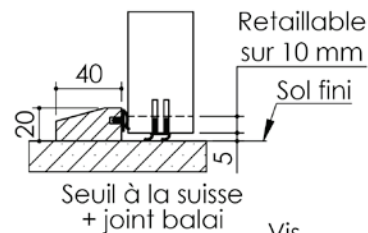

Seuil à la suisse + joint balai

Retractable sur 10 mm  
Retractable sur 10 mm  
Sol fini  
Vis Ø3,5 x 30 (non fournies)

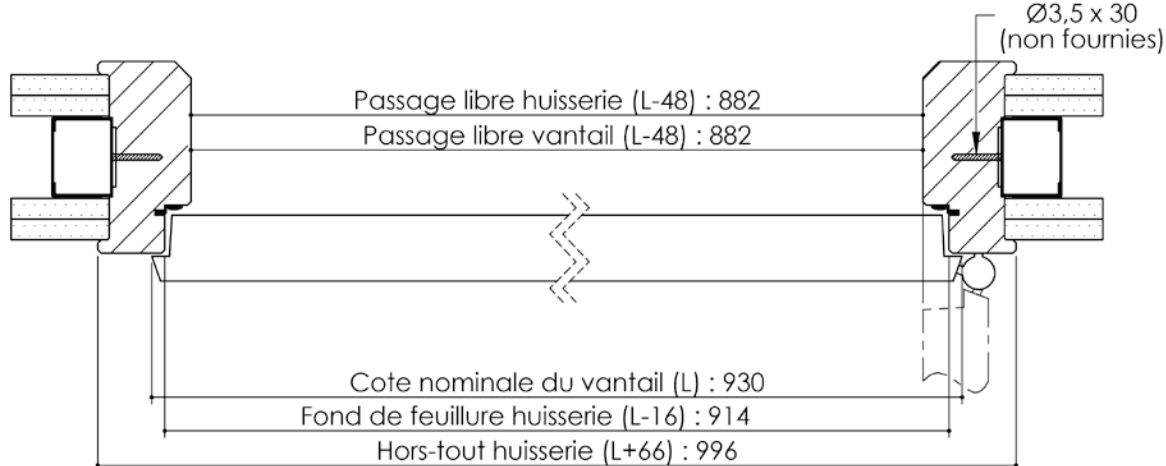

Cahier technique