

# Plan PB-9-1V \_ Ind3 : Huisserie bois - Pose sur cloison plaques de plâtre

Gamme Porte de Communication

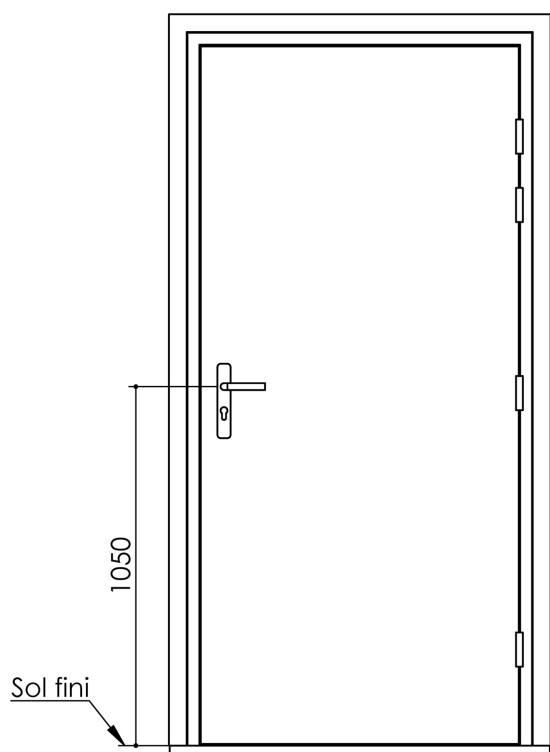

Huisserie non isophonique

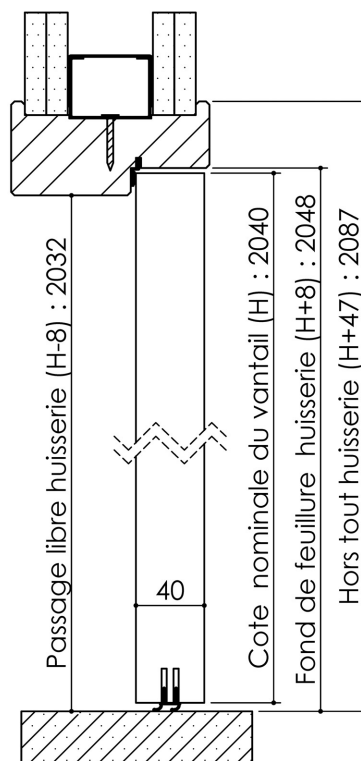
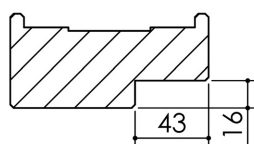

Huisserie isophonique

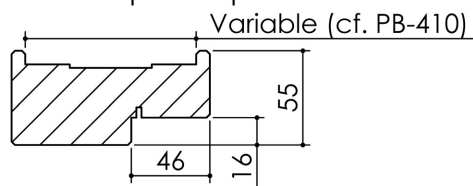

## Variantes bas de porte

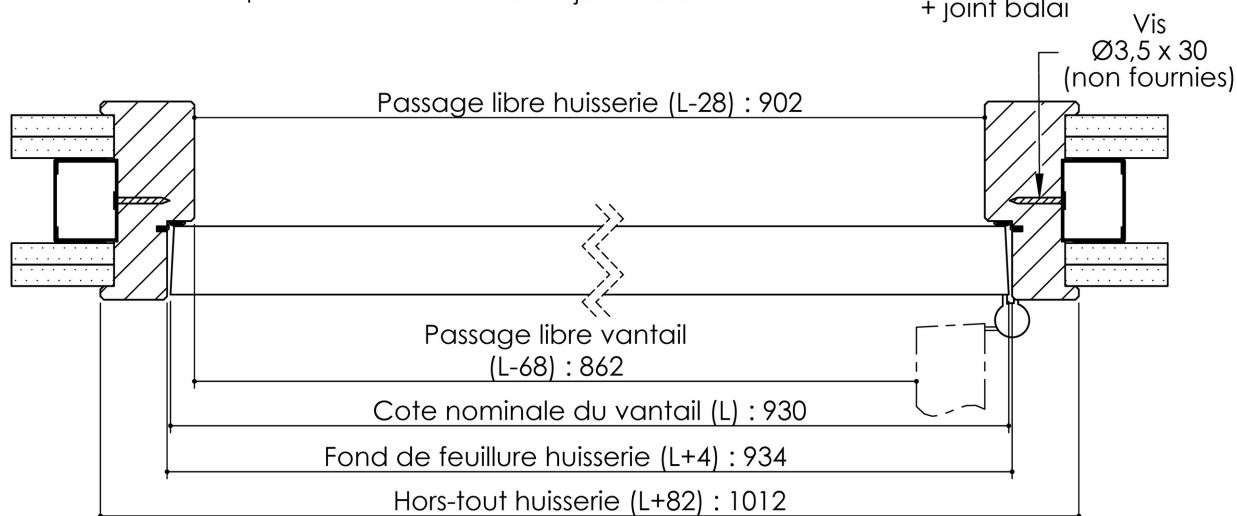
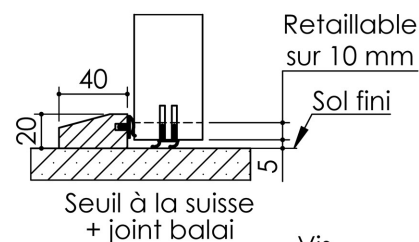
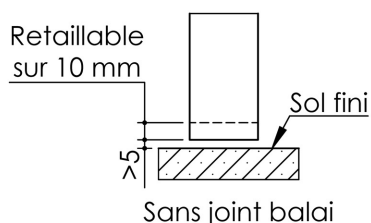
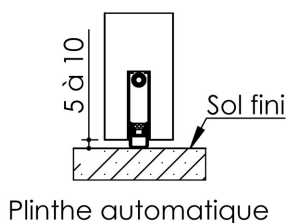

Cahier technique

# Plan PB-9-2V \_ Ind3 : Huisserie bois - Pose sur cloison plaques de plâtre

Gamme Porte de Communication

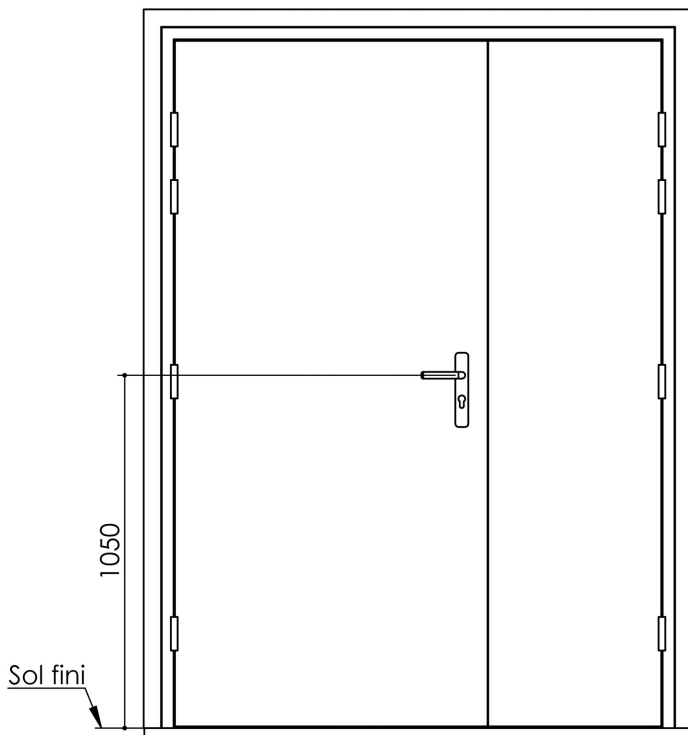

Huisserie non isophonique

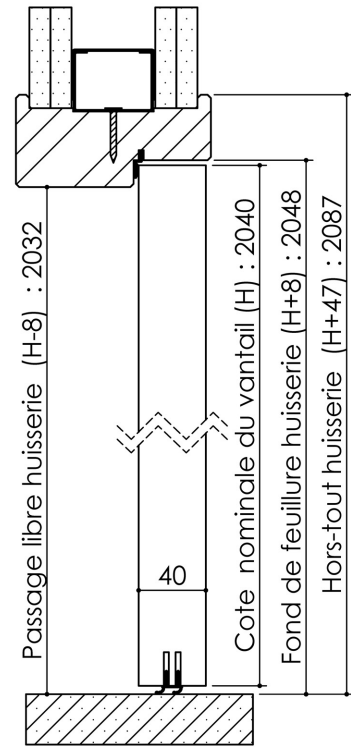
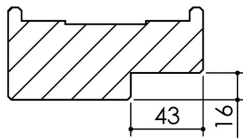

Huisserie isophonique

Variable (cf. PB-410)

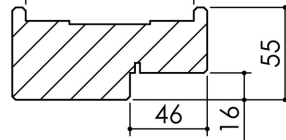

## Variantes bas de porte

