

# Plan PB-6-1V \_ Ind2 : Huisserie métal - Pose en tableau

Gamme Porte de Communication

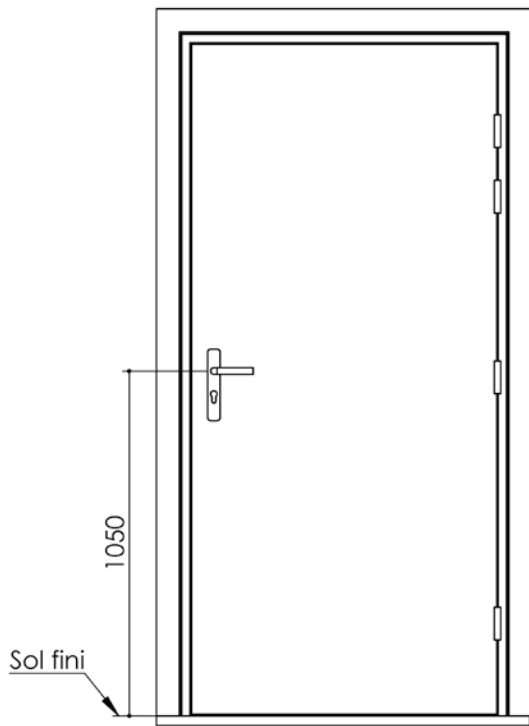

Huisserie non isophonique

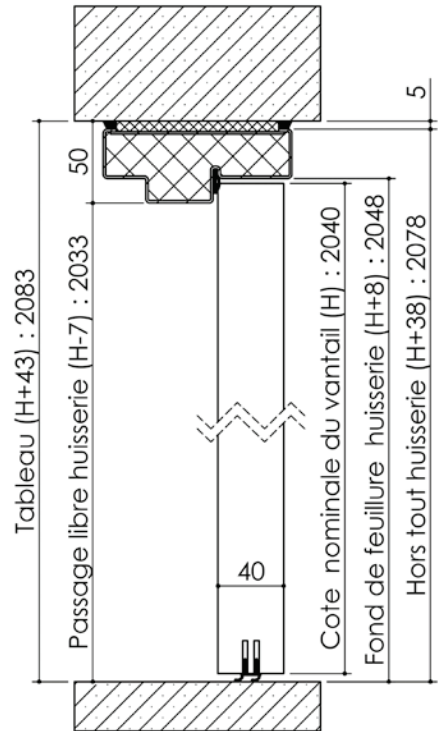
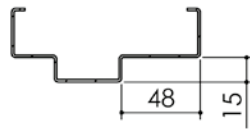

Huisserie isophonique

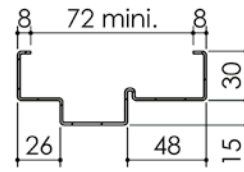

## Variantes bas de porte

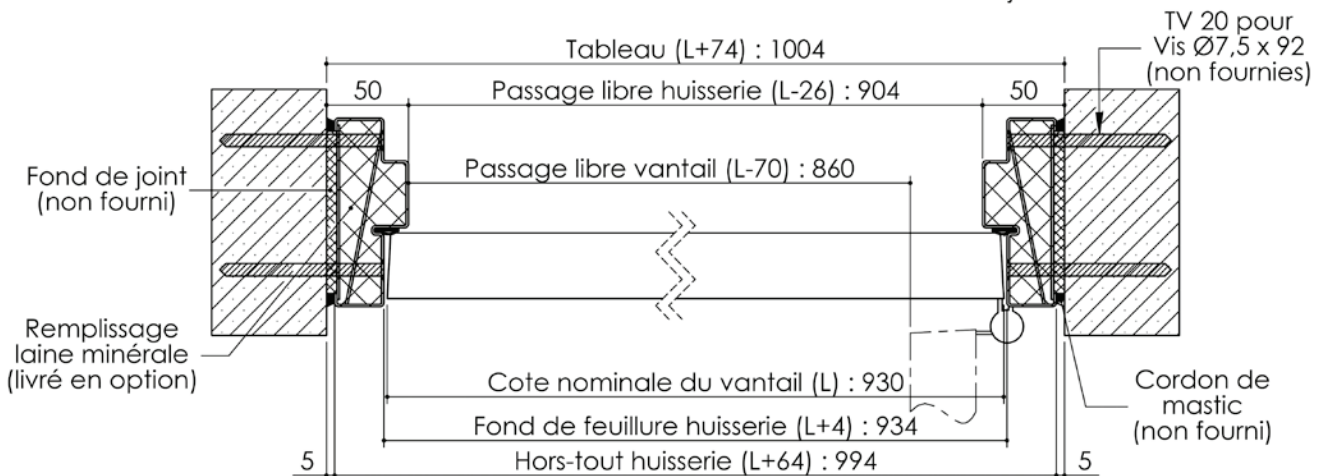
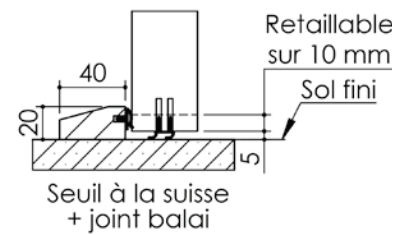
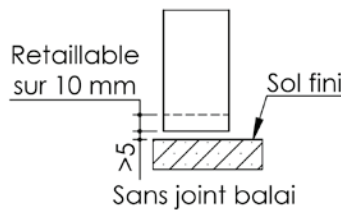
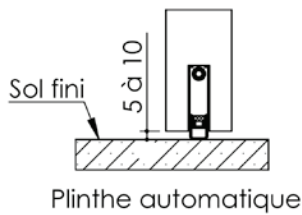

Cahier technique

# Plan PB-25-1V \_ Ind2 : Huisserie métal - Pose en tableau

Gamme Porte de Communication

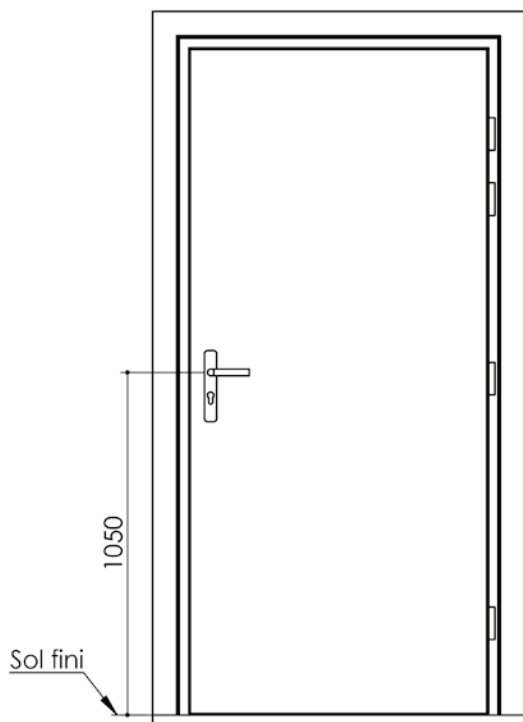

Huisserie non isophonique

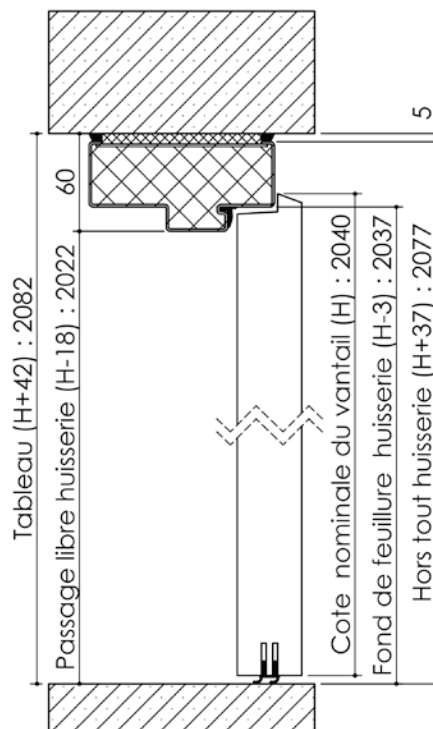

Huisserie isophonique

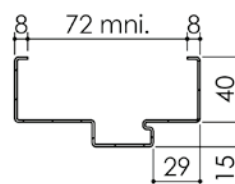
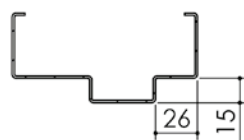

Variantes bas de porte

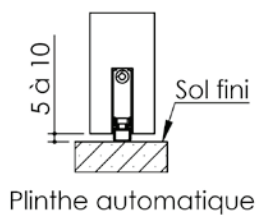

Plinthe automatique

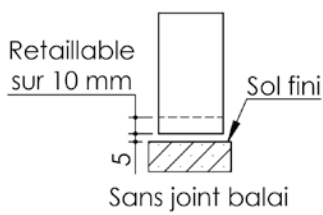

Sans joint balai

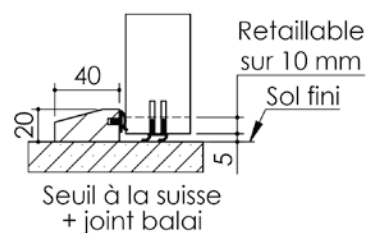

Seuil à la suisse + joint balai

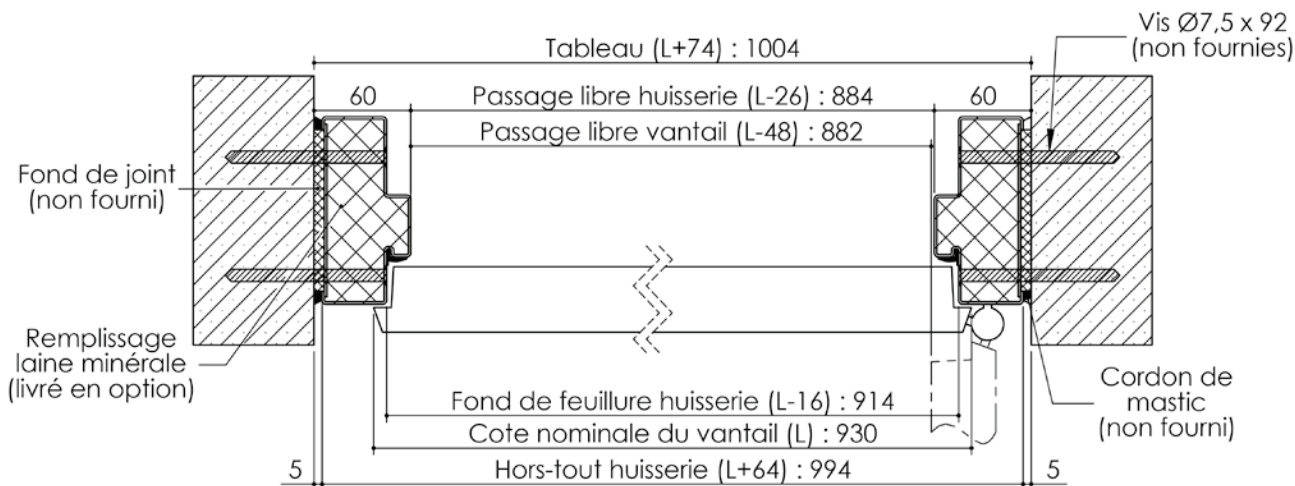

Cahier technique