

Plan PB-3-1V _ Ind1 : Huisserie métal - Pose scellée

Gamme Porte de Communication

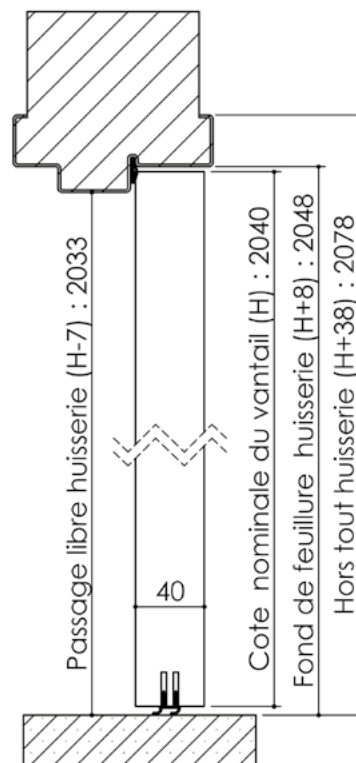

Huisserie non isophonique

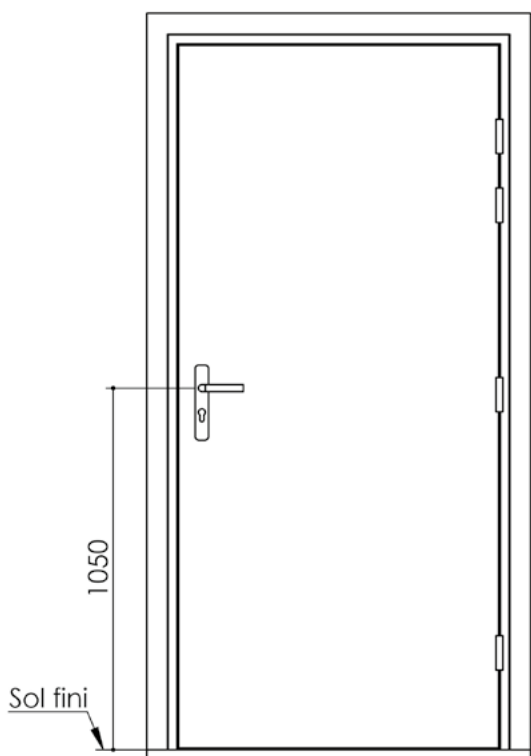
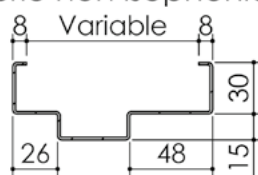

Huisserie isophonique

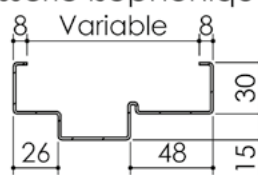

Variantes bas de porte

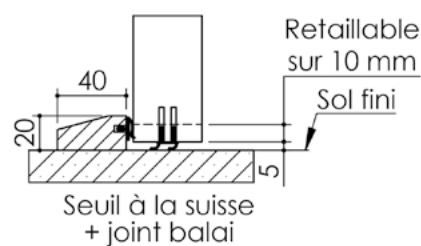
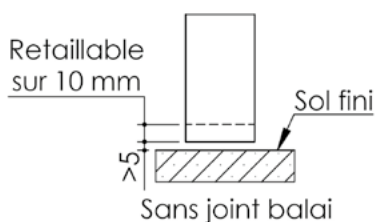
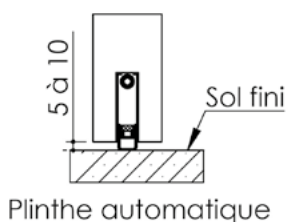

Pattes soudées

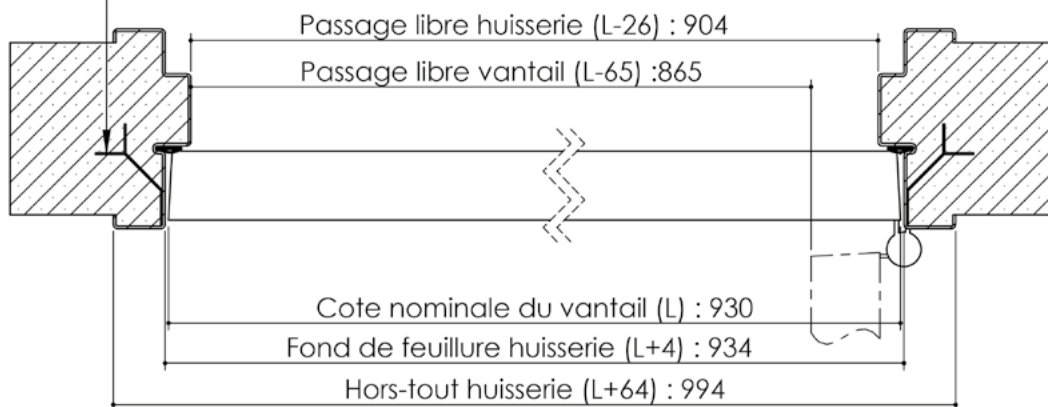

Plan PB-3-2V _ Ind2: Huisserie métal - Pose scellée

Gamme Porte de Communication

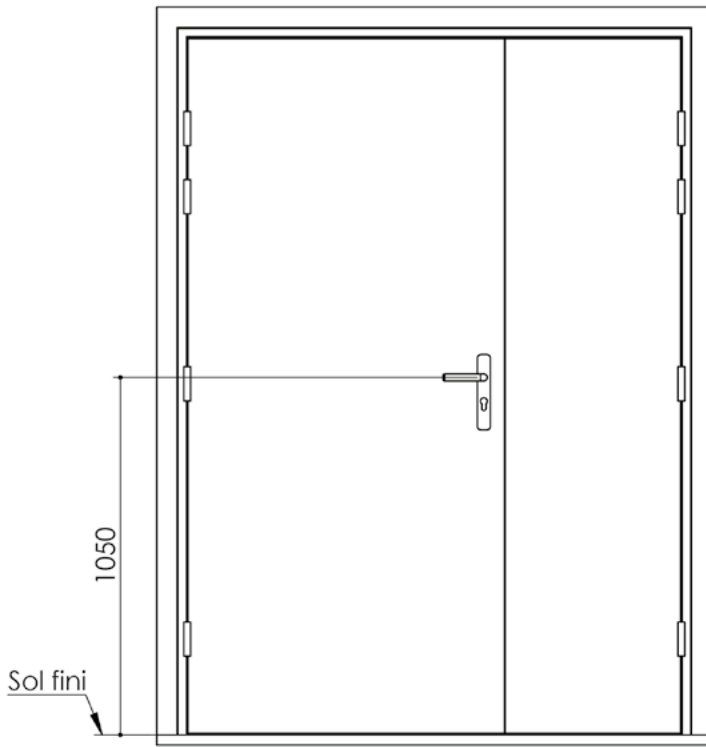

Huisserie non isophonique

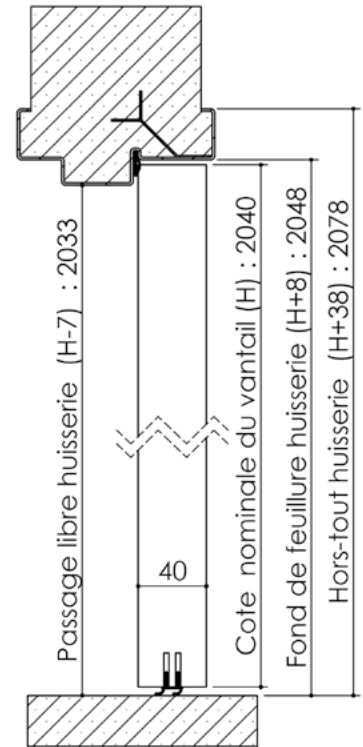
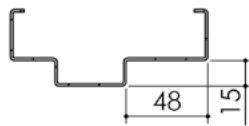

Huisserie isophonique

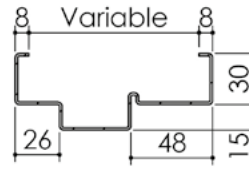

Variantes bas de porte

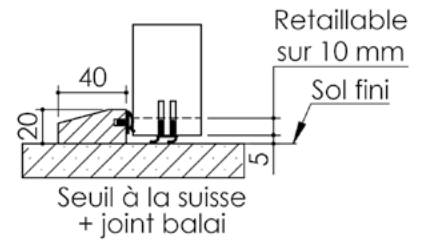
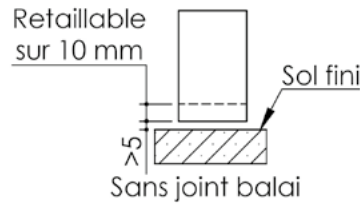
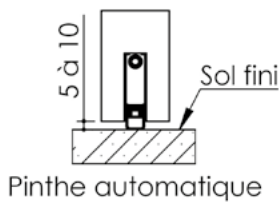

Pattes soudées

