

# Plan PB-268-1V \_ Ind5 : Huisserie bois -

## Pose sur cloison plaques de plâtre

Gamme Porte feu EI30

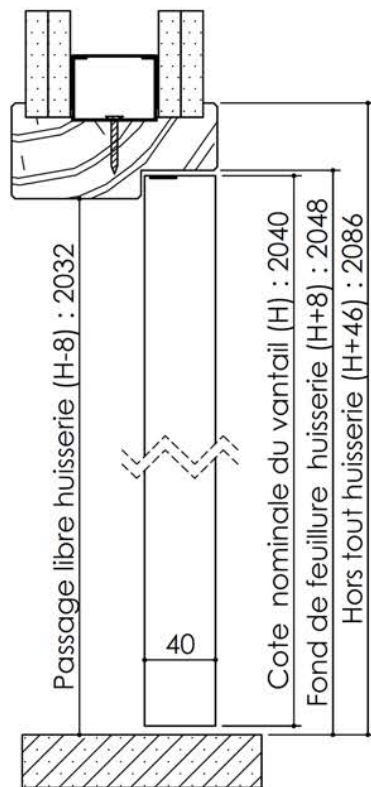
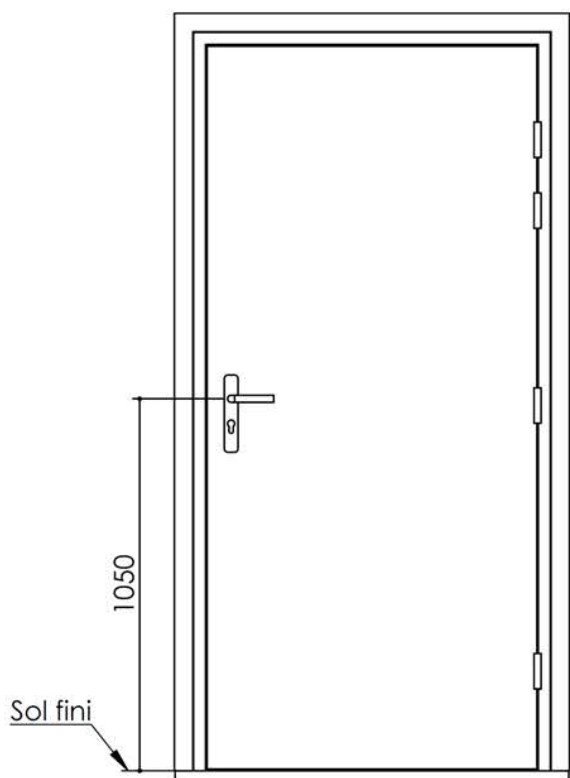

Détail bas de porte

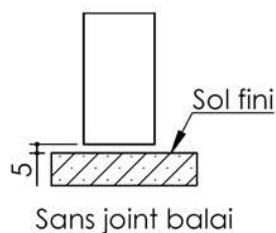

Variante d'étanchéité



Huisserie non isophonique

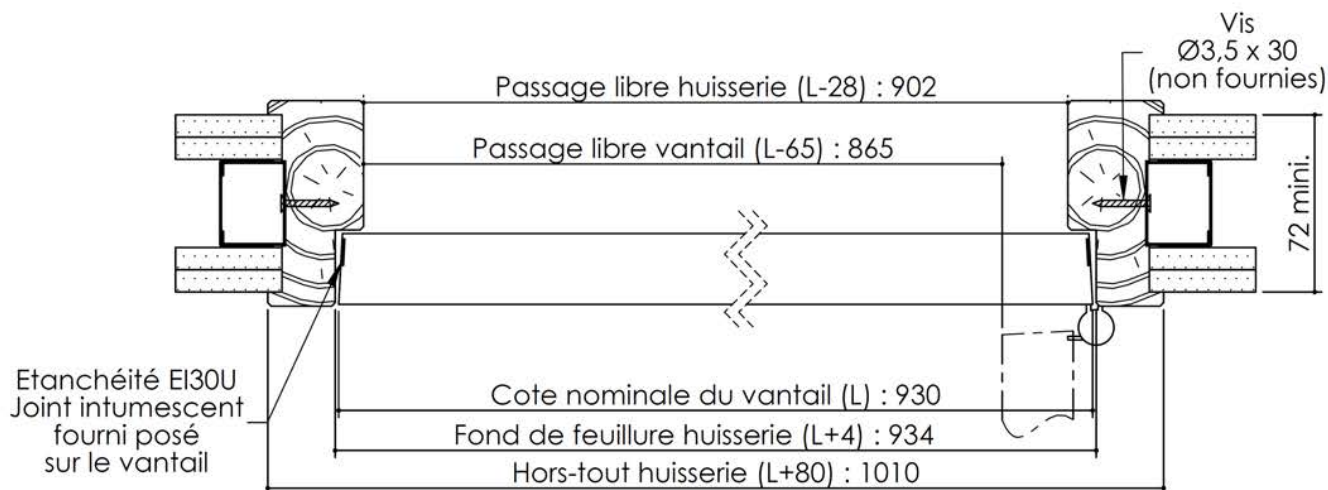
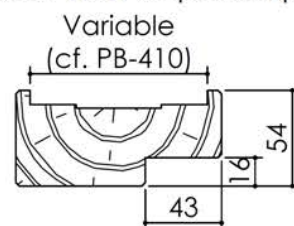

**KEYOR**

PB-268-1V 01/07/2019

Plan non contractuel, Keyor se réserve le droit de modifier ce plan pour des raisons industrielles

# Plan PB-268-2V \_ Ind4 : Huisserie bois - Pose sur cloison plaques de plâtre

Gamme Porte feu EI30

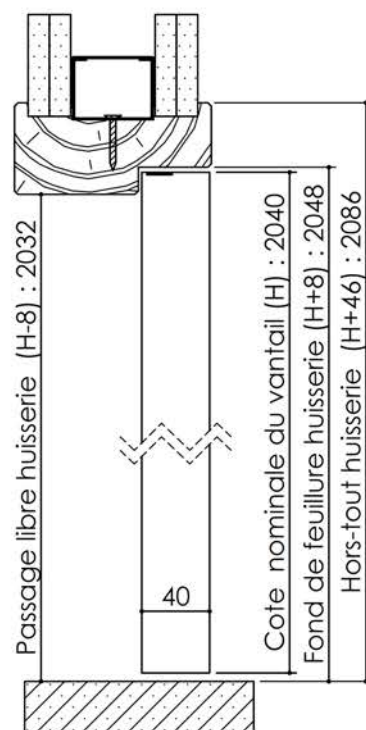
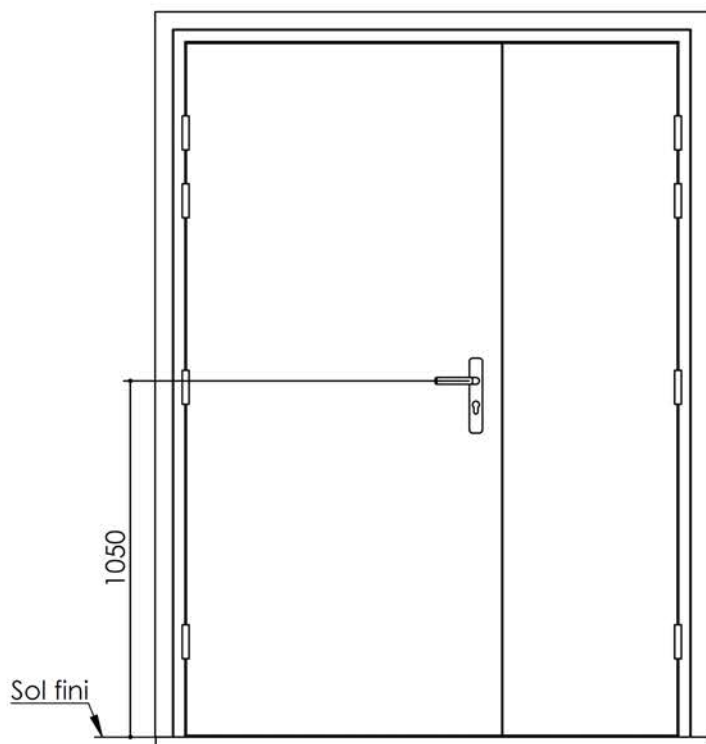

Variante d'étanchéité  
Etanchéité EI30  
Joint intumescent  
fourni posé  
sur l' huisserie



Détail bas de porte

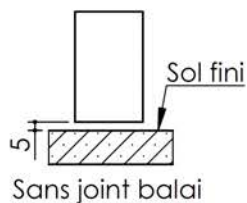

Détail de  
feuillure centrale

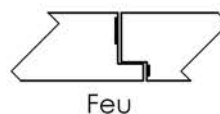

Huisserie non isophonique

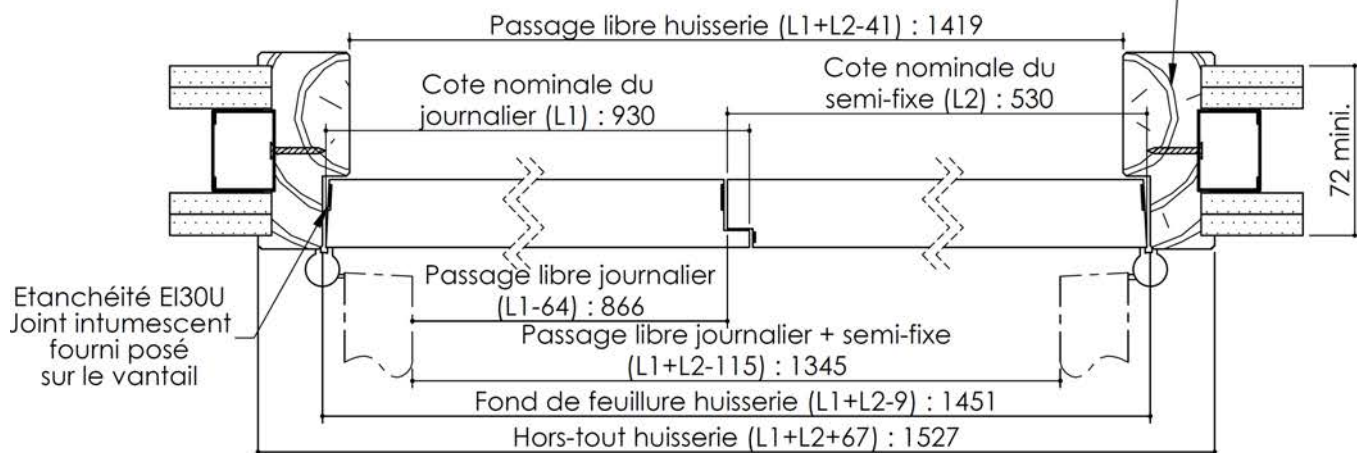
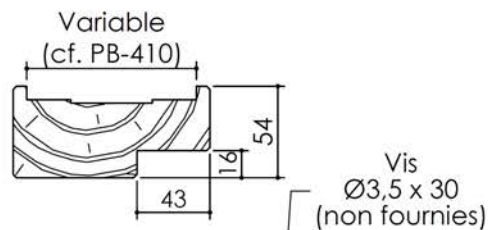

Etanchéité EI30U  
Joint intumescent  
fourni posé  
sur le vantail

**KEYOR**

PB-268-2V 01/07/2019

Plan non contractuel, Keyor se réserve le droit de modifier ce plan pour des raisons industrielles