

Plan PB-2-1V _ Ind1 : Bâti bois - Pose scellée

Gamme Porte de Communication

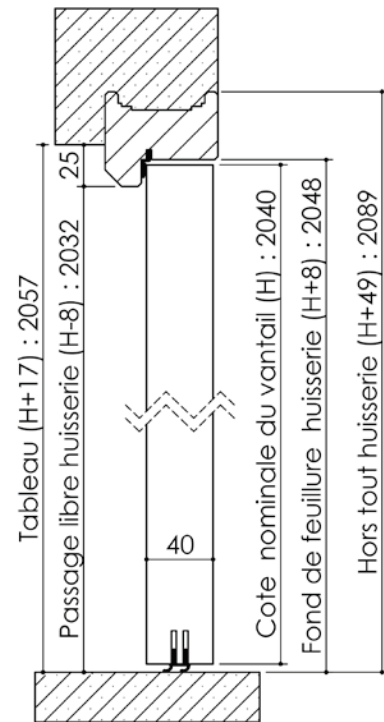
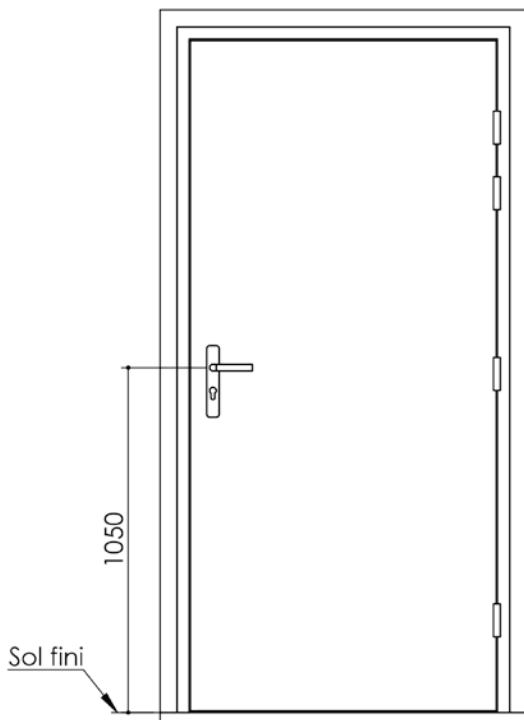

Huisserie non isophonique

Huisserie isophonique

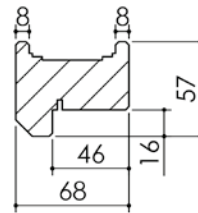
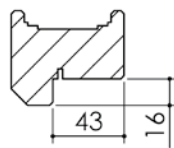

Variantes bas de porte

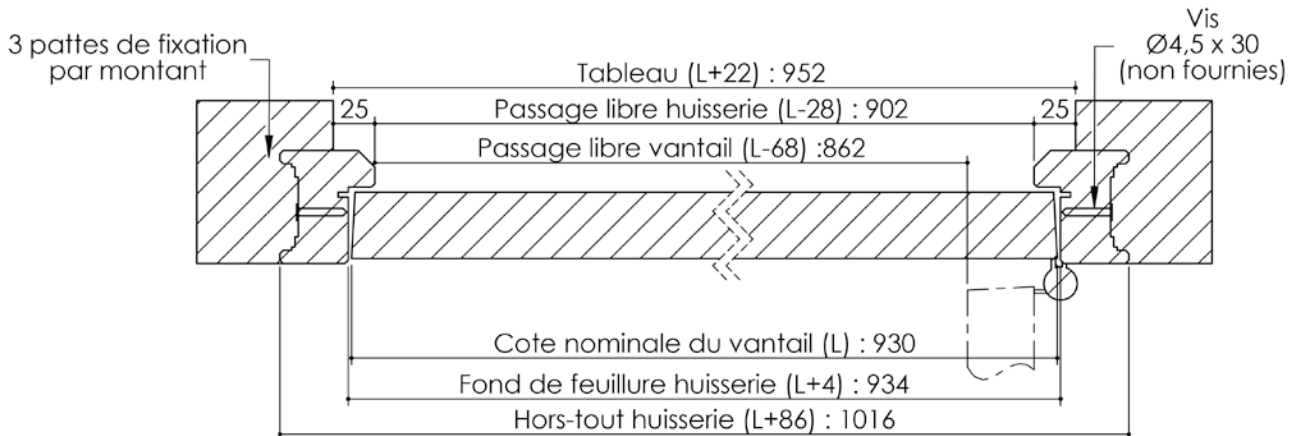
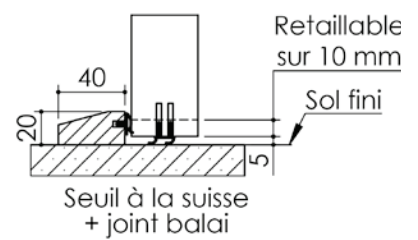
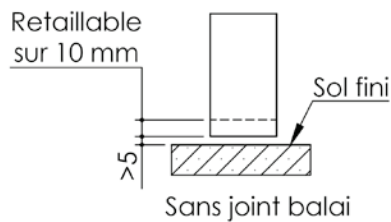
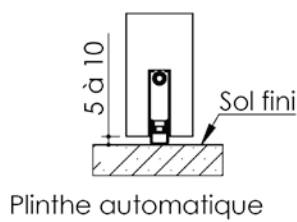

Cahier technique

Plan PB-21-1V _ Ind1 : Bâti bois - Pose scellée

Gamme Porte de Communication

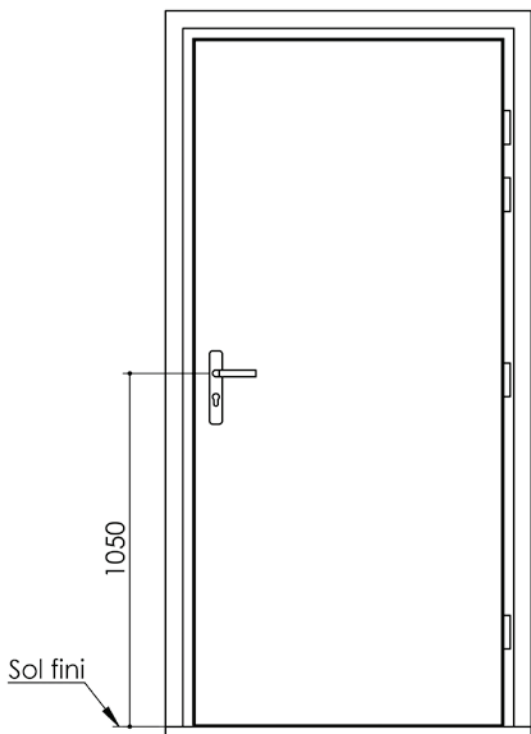

Huisserie non isophonique

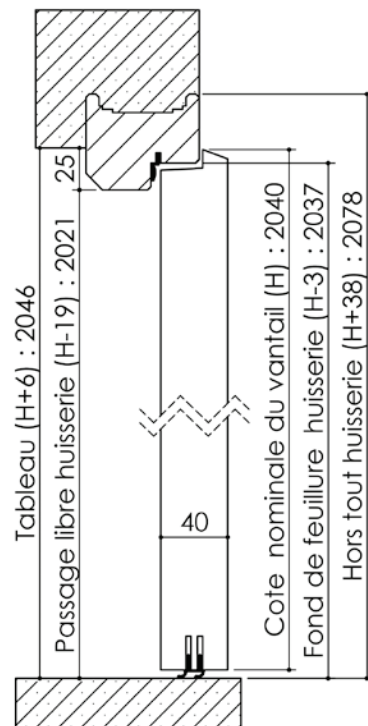

Huisserie isophonique

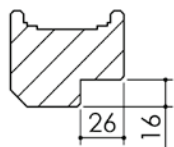

Variantes bas de porte

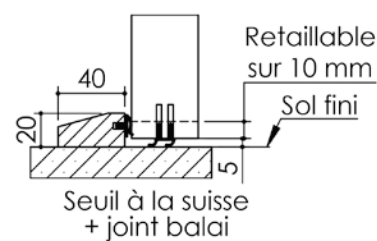
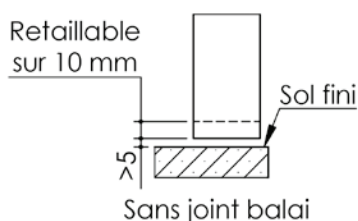
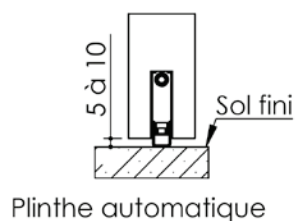
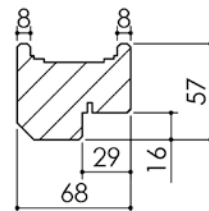

3 pattes de fixation par montant

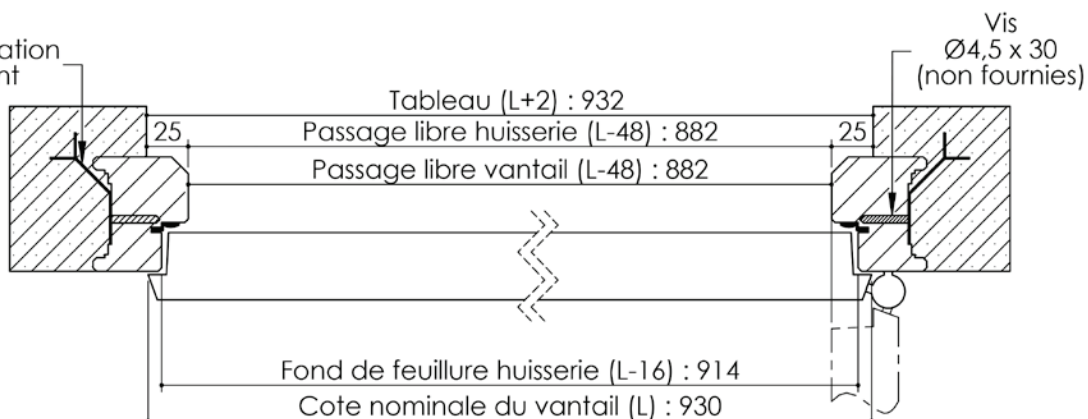

Cahier technique