

Plan PB-160-1V _ Ind2 : Huisserie mixte - Pose sur cloison plaque de plâtre

Gamme Porte feu EI90 Double Action

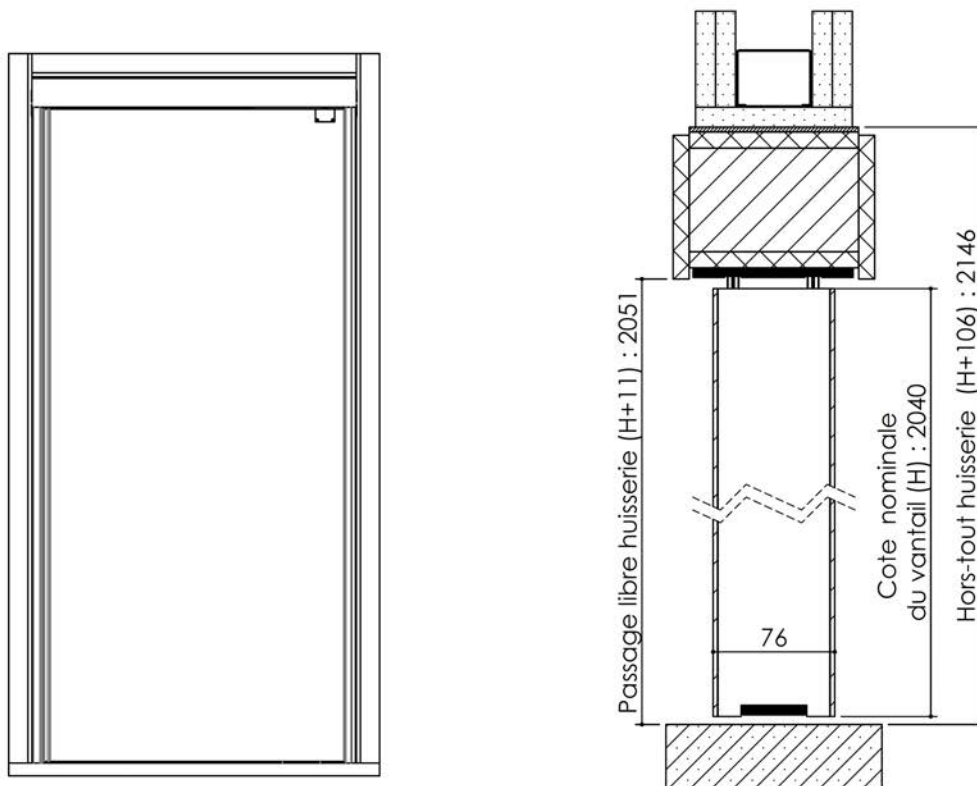

Montant côté
battement

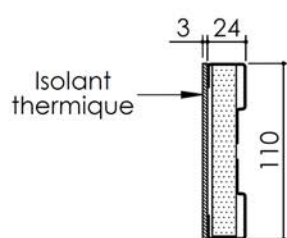

Traverse

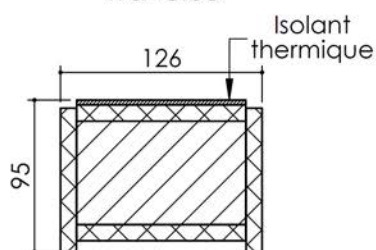

Montant côté
articulation

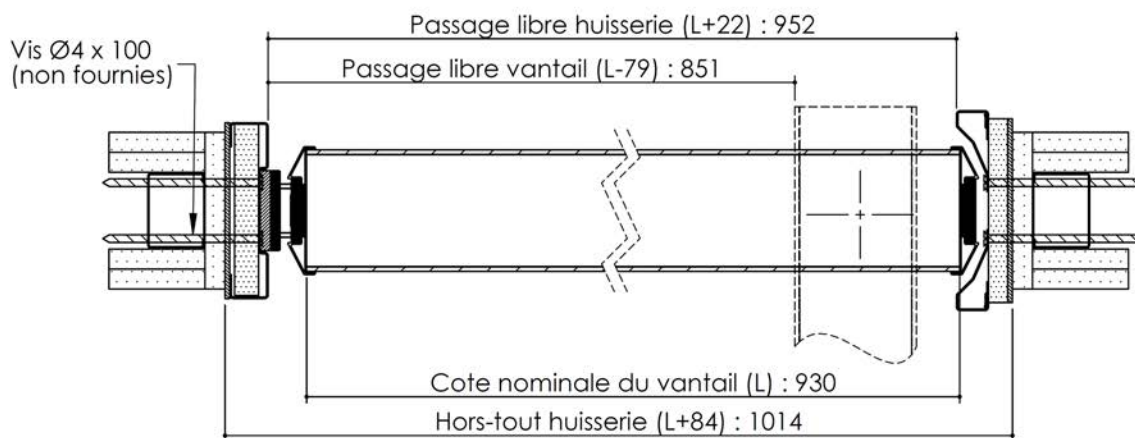
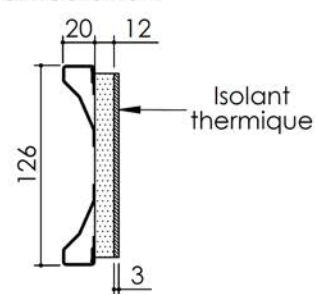

PB-160-1V 01/07/2019

Plan non contractuel, Keyor se réserve le droit de modifier ce plan pour des raisons industrielles

Plan PB-160-2V - Ind3 : Huisserie mixte - Pose sur cloison plaque de plâtre

Gamme Porte feu EI90 Double Action

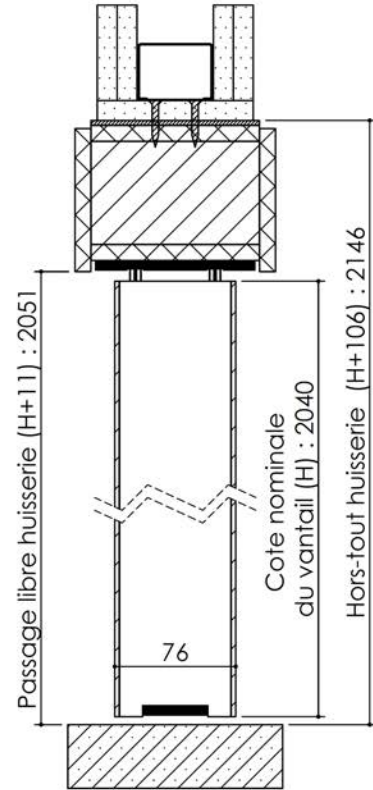
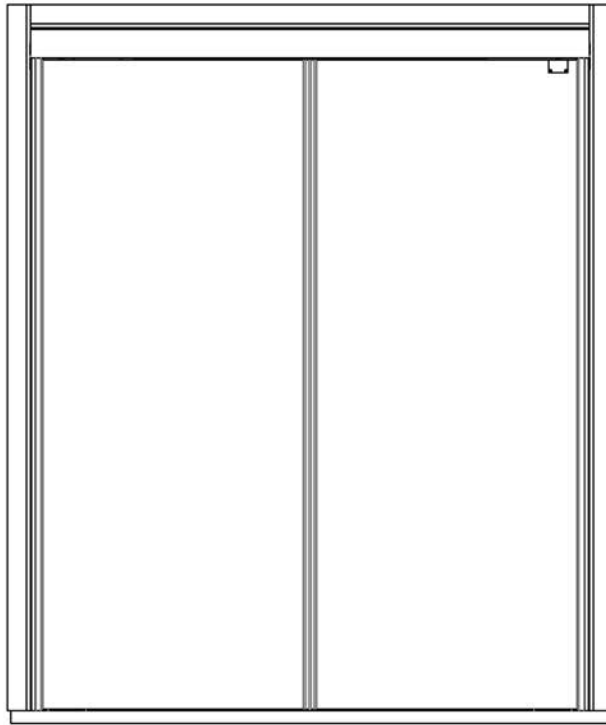

Montant côté articulation

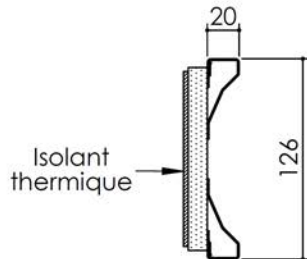

Traverse

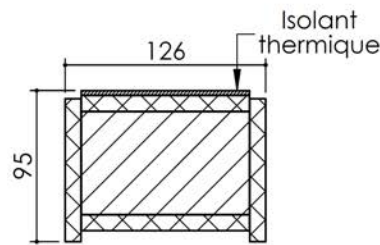

Montant côté articulation

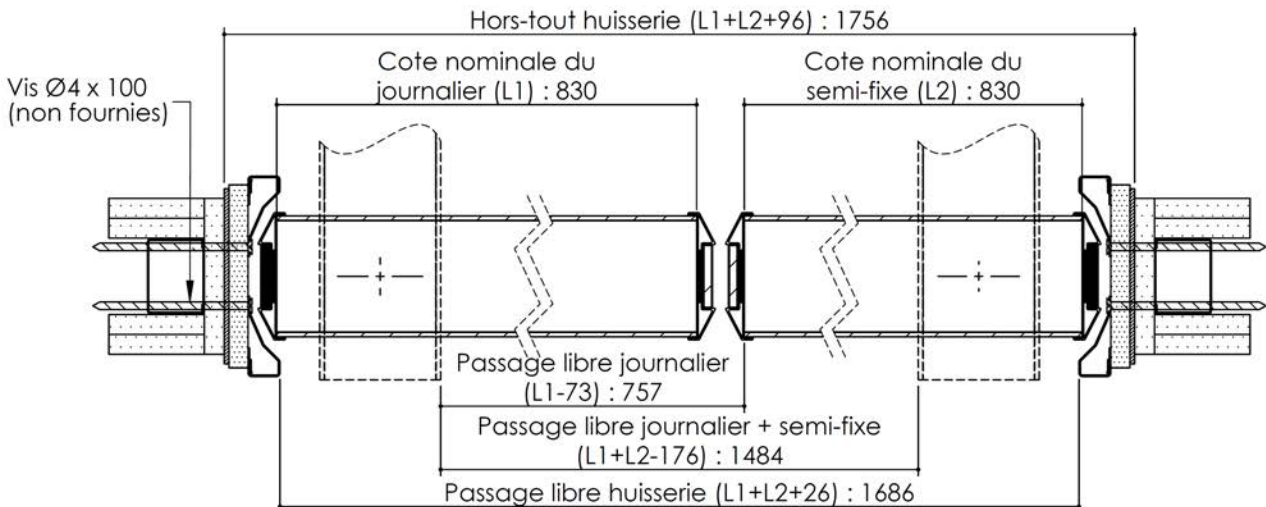
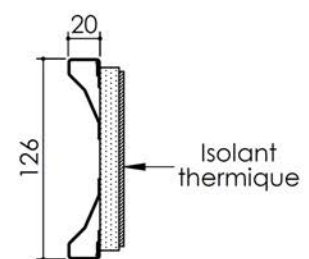

PB-161-2V 01/07/2019

Plan non contractuel, Keyor se réserve le droit de modifier ce plan pour des raisons industrielles