

# Plan PB-124-1V \_ Ind1 : Huisserie métal - Pose banchée

Gamme Porte Acoustique EI60

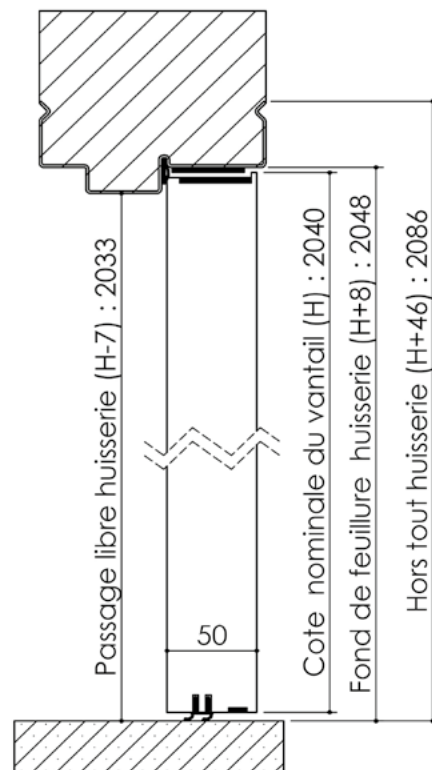

## Huisserie isophonique

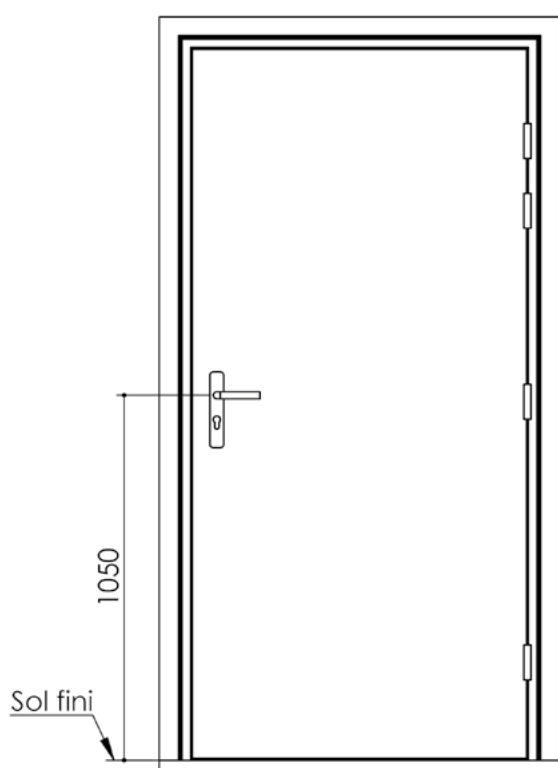
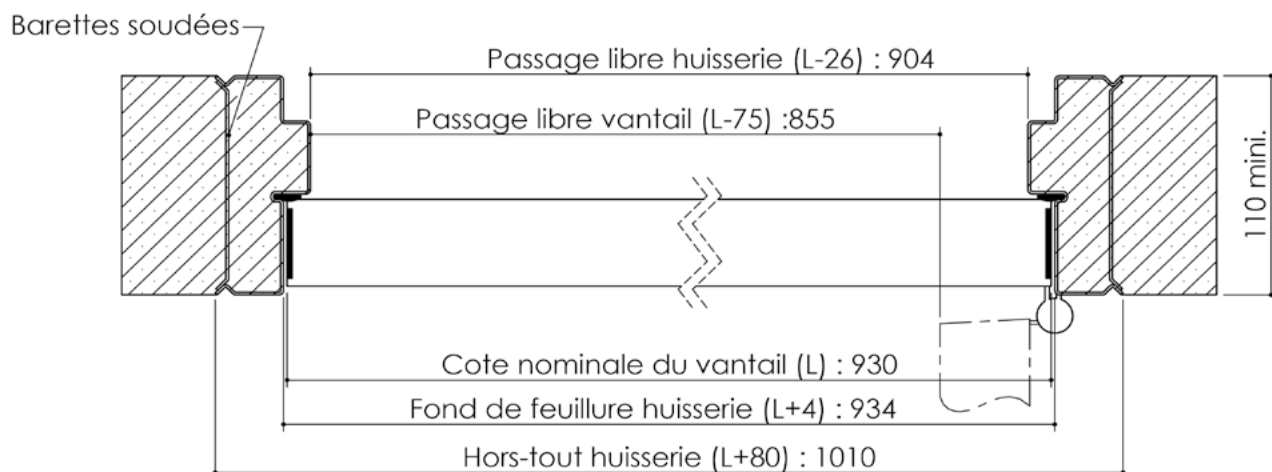
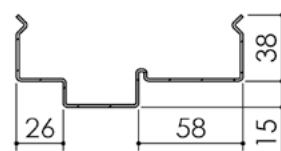
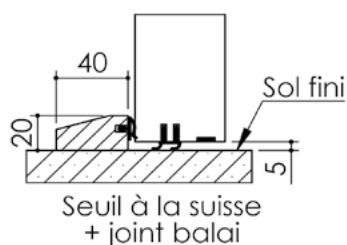
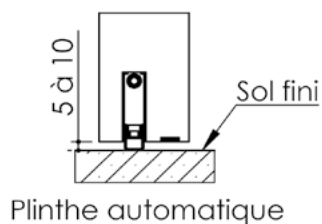

Cahier technique

# Plan PB-124-2V \_ Ind2 : Huisserie métal - Pose banchée

Gamme Porte Acoustique EI60

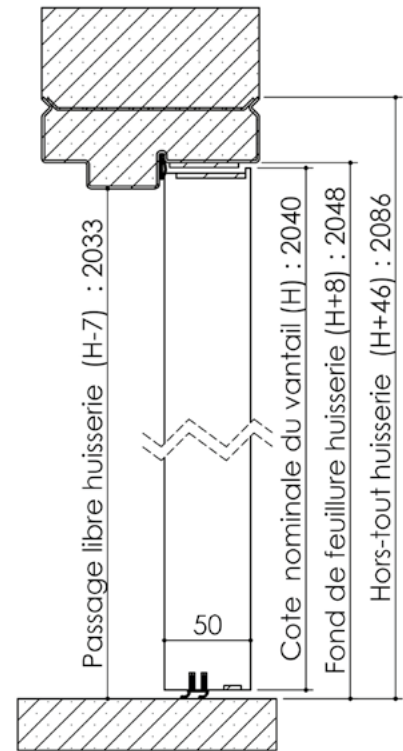
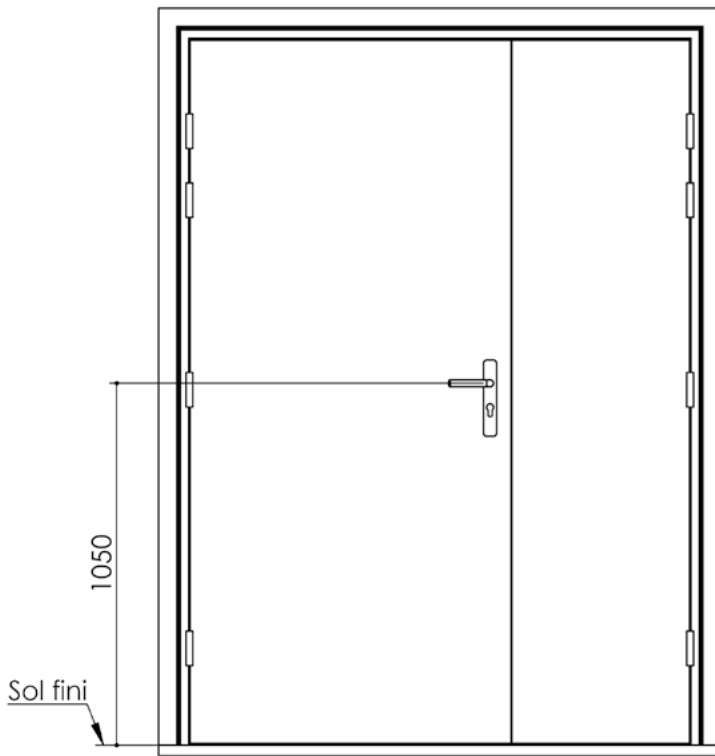

Huisserie isophonique

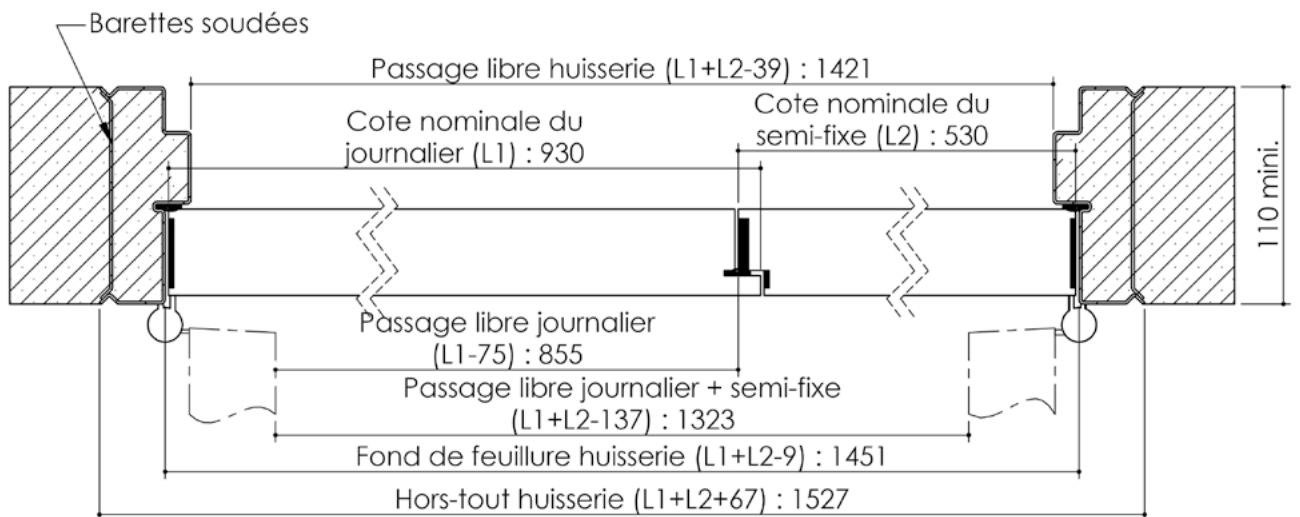
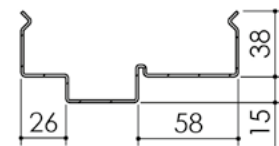
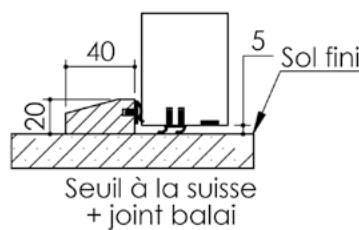
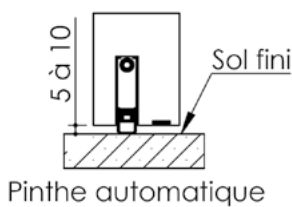

Cahier technique