

Plan PB-121-1V _ Ind3 : Bâti bois - Pose scellée

Gamme Porte Acoustique EI60

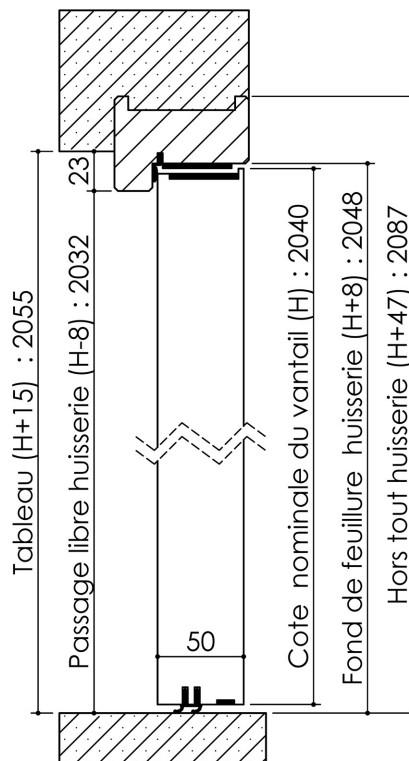

Huisserie isophonique

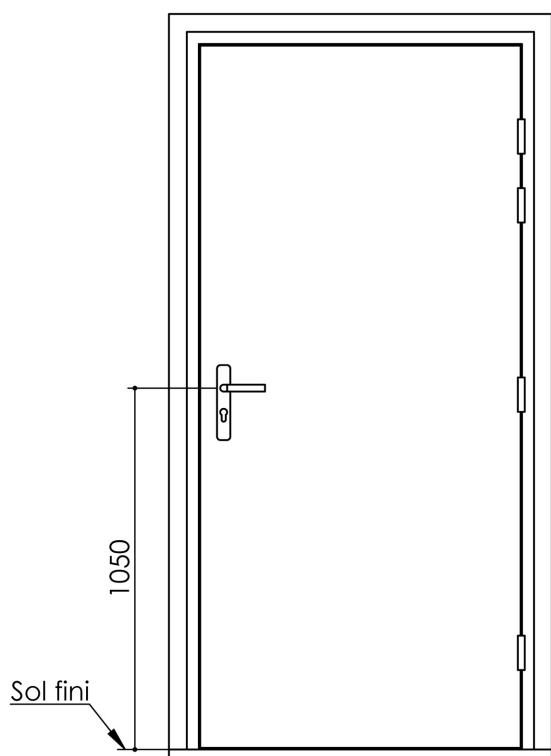
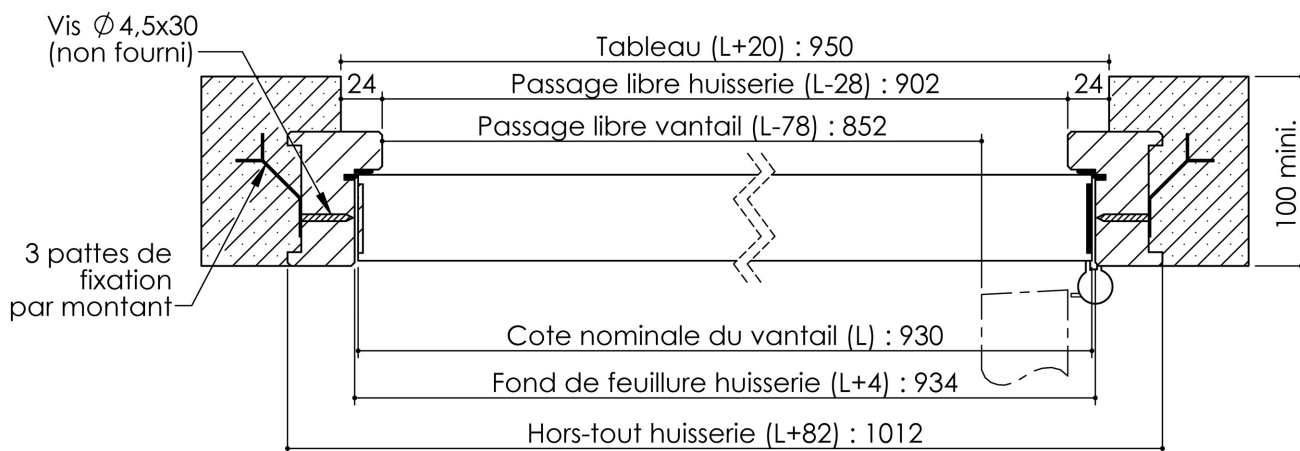
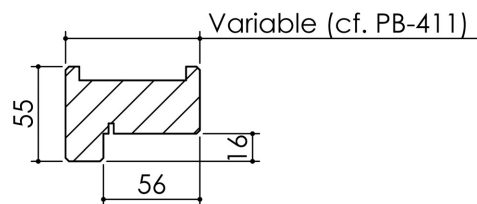
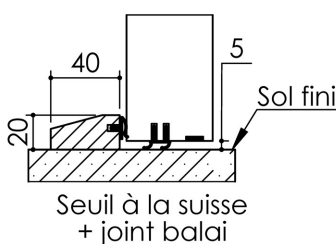
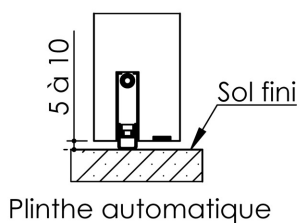

Cahier technique

Plan PB-121-2V _ Ind2 : Bâti bois - Pose scellée

Gamme Porte Acoustique EI60

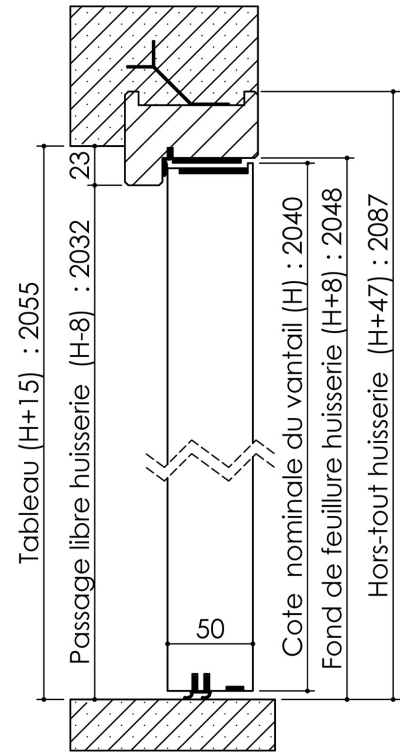
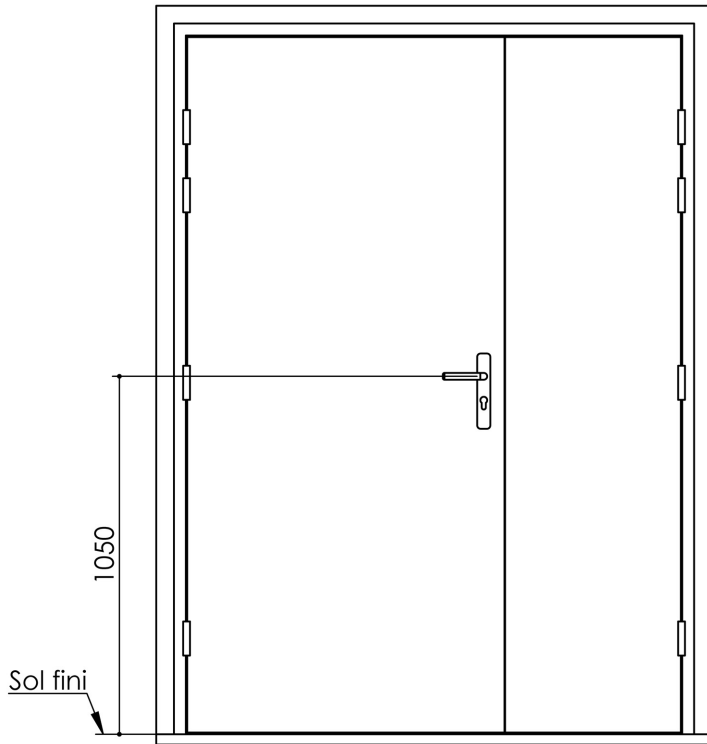

Détail de feuillure centrale



Variante bas de porte

Huisserie isophonique

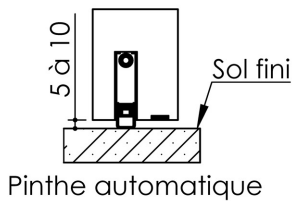

Pinthe automatique

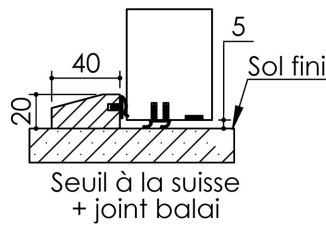

Seuil à la suisse + joint balai

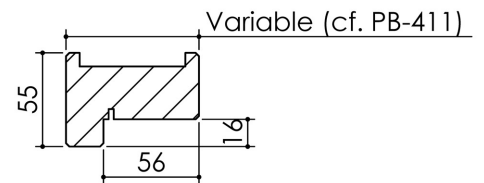

Variable (cf. PB-411)

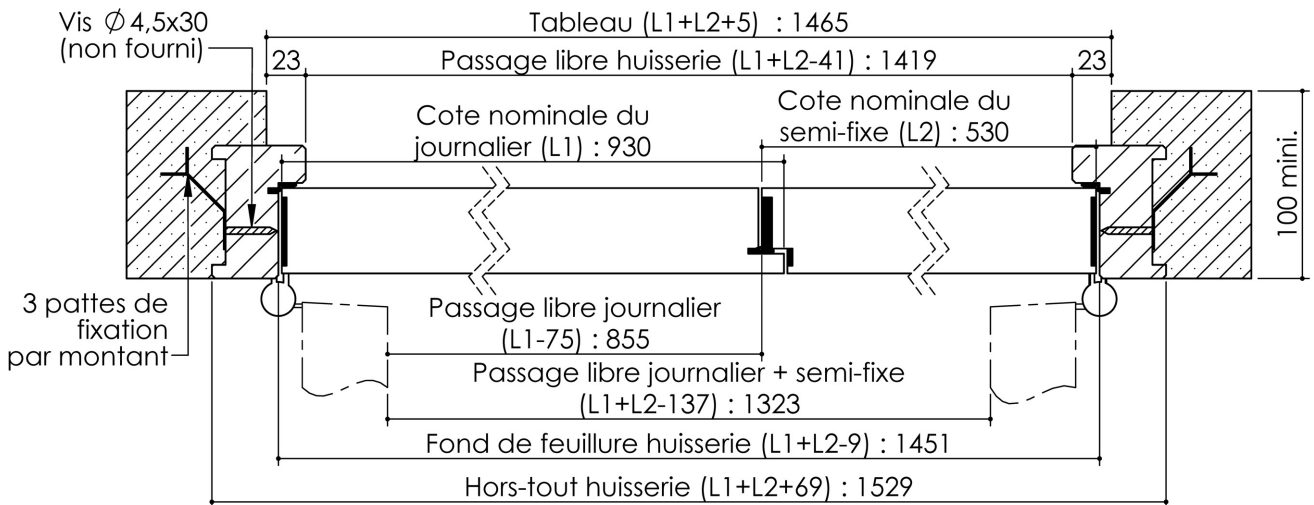

Cahier technique