

# Plan PB-120-1V \_ Ind3 : Bati métal - Pose scellée

Gamme Porte Acoustique EI60

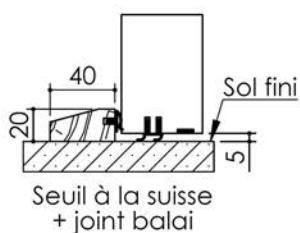

Huisserie isophonique

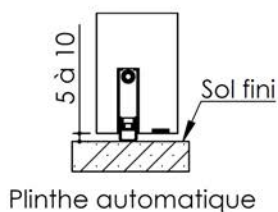
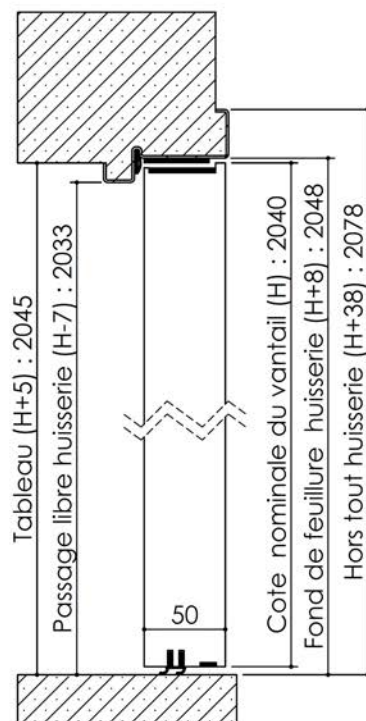
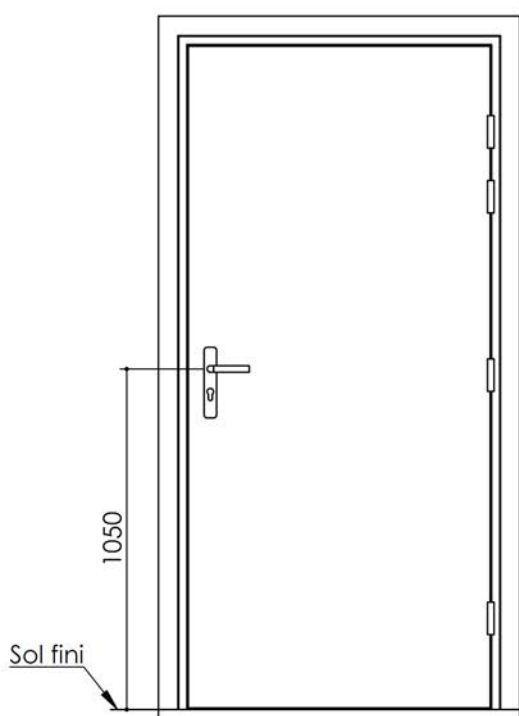
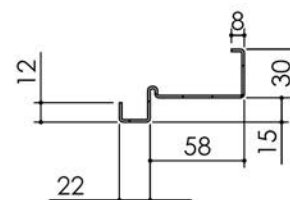

Pattes soudées

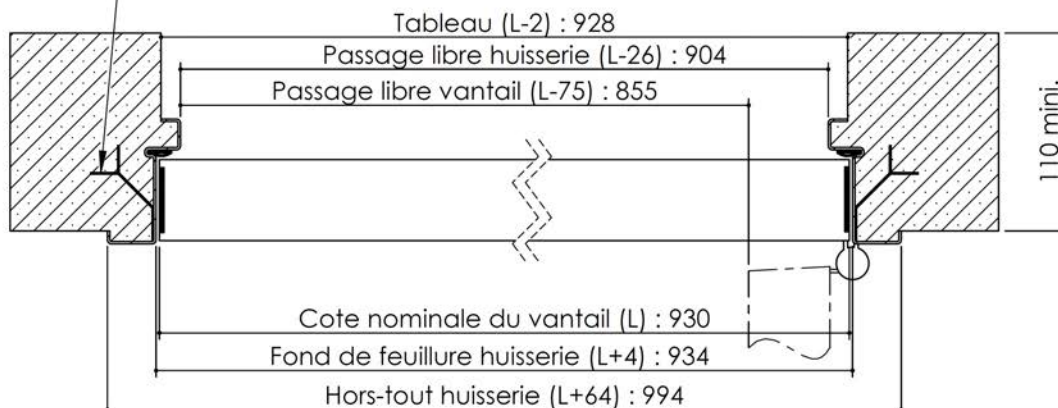

**KEYOR**

PB-120-1V 01/07/2019

Plan non contractuel, Keyor se réserve le droit de modifier ce plan pour des raisons industrielles

# Plan PB-120-2V \_ Ind3 : Bati métal - Pose scellée

Gamme Porte Acoustique EI60

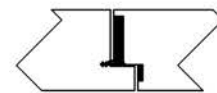
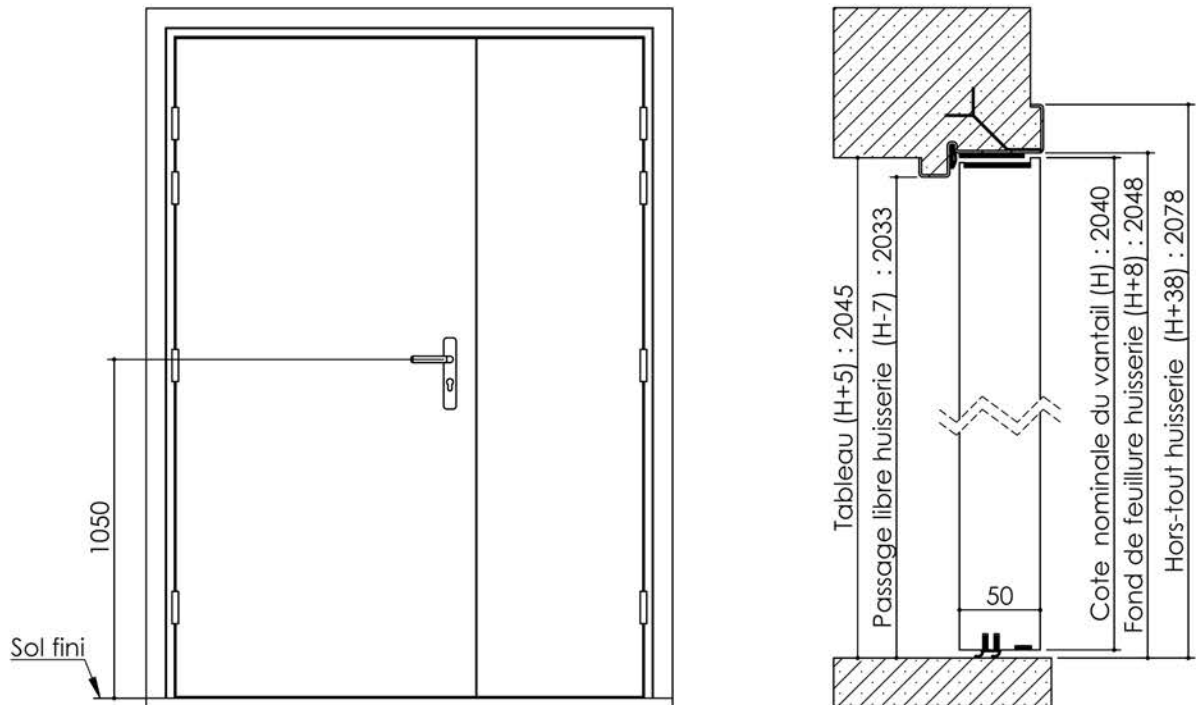

Acoustique

Huisserie isophonique

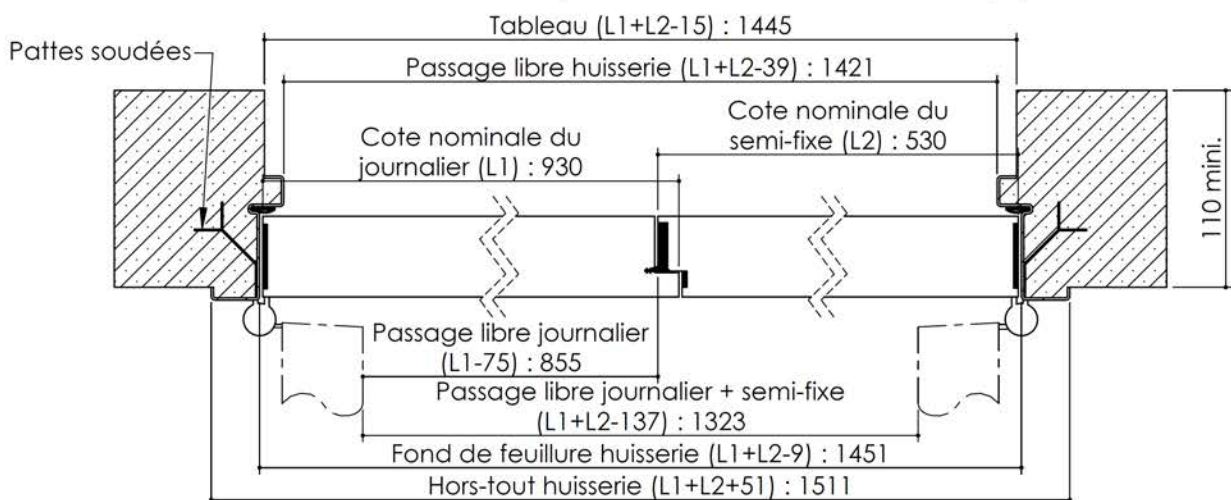
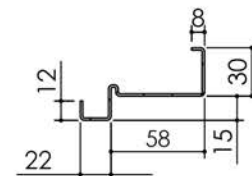
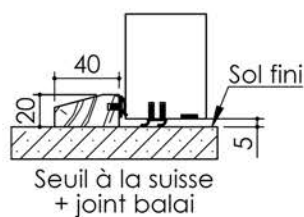
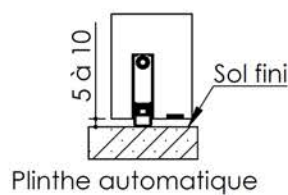

**KEYOR**

PB-120-2V 01/07/2019

Plan non contractuel, Keyor se réserve le droit de modifier ce plan pour des raisons industrielles